

The N322RHT is a digital controller for relative humidity and temperature. Its 2 relay outputs can be configured independently as control or alarm, either for temperature or relative humidity.

The humidity and temperature sensor, sold separately, is protected by a polyamide capsule and have 3 or 6 meters long cables.

The features of a particular model (mains supply, digital communication, etc) are identified by the label placed on the controller body.

SPECIFICATIONS

Sensor Input: Humidity measurement

- Range:** 0 and 100 % RH;
- Accuracy:** Refer to Fig. 1;
- Repeatability:** ± 1 % RH;
- Hysteresis:** ± 1 % RH;
- Linearity error:** << 1 % RH;
- Stability:** < 1 % RH / year;
- Response time:** Around 8 s to reach 63 % of a fast input change. Valid at 25 °C and 1 m/s airflow.

Sensor Input: Temperature measurement

- Range:** -20 and 100 °C;
- Accuracy:** Refer to Fig. 1;
- Repeatability:** ±0.1 °C;
- Response time:** up to 30 seconds in slow moving air.

Warm-up: 15 minutes

Measurement resolution: RH: 1 %
T: 0.1° from -19.9 to 119.9°

Note: The equipment keeps its precision all over the range, despite the lack of display resolution in a part of the range does not allow its visualization.

OUTPUT1: Relay SPDT; 1 HP 250 Vac / 1/3 HP 125 Vac (16 A Resistive)
..... Optional: Pulse, 5 Vdc, 25 mA max.

OUTPUT2: Relay: 3A / 250 Vac, SPST

POWER SUPPLY: Voltage: 100-240 Vac/dc (± 10 %)
Optional: 24 Vdc/ac (12-30 Vdc/ac)
Frequency: 50-60 Hz
Consumption: 5 VA

Dimensions: Width x Height x Depth: 75 x 33 x 75 mm
Panel cut-out: 70 x 29 mm
Weight: 100 g

Electronic module operating environment: 0 to 40 °C / 20 to 85 % RH

Sensor module operating environment: -20 to 100 °C / 0 to 100 % RH

Case: Polycarbonate UL94 V-2.

Protection: box IP42, front panel IP65, sensors capsule IP40 (sold separately).

Suitable wiring: Up to 4.0 mm².

RS-485 digital communication; RTU MODBUS protocol (optional).

Serial interface not isolated from input circuitry.

Input circuitry isolated from power supply, except in the 24 V powered model.

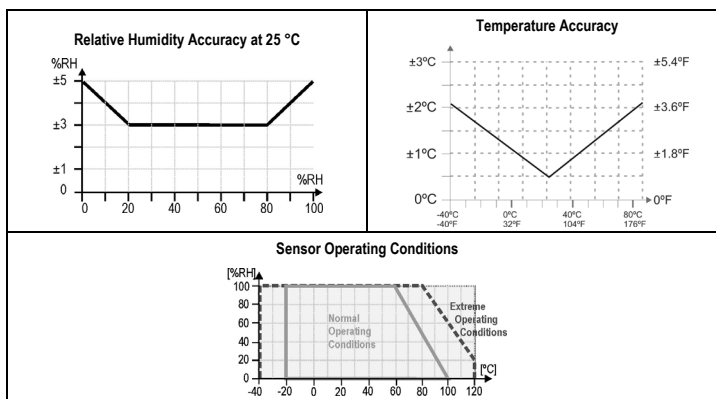

Fig. 1 - RH and Temperature accuracies

IMPORTANT

The sensor used in this controller may be damaged or lose calibration if exposed to aggressive atmospheres with high concentrations as Chloride Acid, Nitride Acid, Sulphuric Acid or Ammonia. Acetone, Ethanol and Propylene Glycol may cause reversible measurement drifts.

Fine trimming in the indication of RH and Temperature are available at the parameters **DFH** and **DFE**, in the configuration level of parameters.

ELECTRICAL WIRING

The figure below indicates the connection to the sensor, power supply and controller output, as well as a connection example.

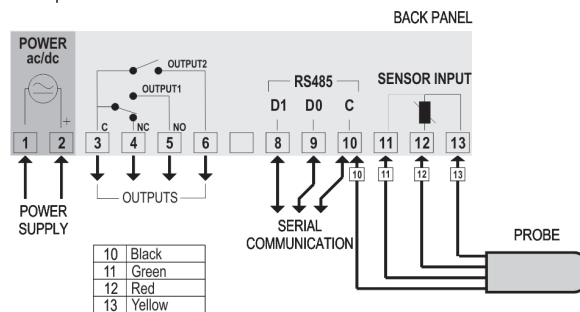

Fig. 2 - N322RHT terminals

Recommendations for installation

- The humidity sensor Conductors shall go through the system plant separately from the control and feeding output conductors, if possible in grounded electrical ducts.
- The controller feeding shall be preferably provided from a proper instrumentation network with a phase different from the one used for the control output.
- It is recommendable to use RC FILTERS (47 R and 100 nF, series) in contactor coils, solenoids, etc.

WORKING WITH THE CONTROLLER

The controller operates on the outputs OUTPUT1 and OUTPUT2 to lead the measured variable (temperature or humidity) to the intended value, defined by the setpoint (**SP1** and **SP2**).

OUTPUT1 and OUTPUT2 can operate either as control outputs, when they operate directly on the system load (resistance, compressor, humidifier, etc.) or as alarm outputs that operate notifying the operator about the occurrence of any specific situation, defined by the user. The operation modes are presented below and they can be defined on parameters **RC1** and **RC2**.

0 - Reverse control action.

Activates the corresponding OUTPUT when the process variable (RH or temperature) is **below the setpoint** of that output. Normally used for heating control.

1 - Direct control action.

Activates the output whenever the process variable is **above the setpoint** for that output. The direct action is used for refrigeration control.

2 - Low alarm

Minimum value alarm, indicates that the process value is **below the alarm setpoint** defined for the output.

3 - High alarm

Maximum value alarm, indicates that the process is **above the alarm setpoint** defined for that output.

4 - Low alarm with initial blocking.

Identical to the Low Alarm, with the addition of the initial blocking feature explained in note below.

5 - High alarm with initial blocking.

Identical to the High Alarm, with the addition of the initial blocking feature explained in note below.

6 - Inside Range Alarm.

Activates the output when the process variable is **within** the interval defined by:

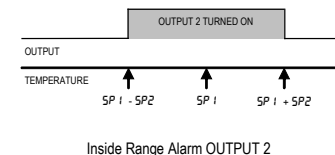

7 - Outside Range Alarm.

Activates the output when the process variable is **outside** the interval defined by:

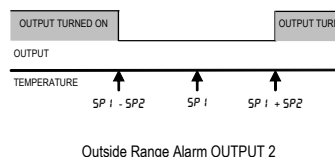

8 - Inside the range alarm with initial blocking.

Identical to the Inside the Range Alarm with the addition of the initial blocking feature, describe in note below.

9 - Outside the Range Alarm With Initial Blocking.

Identical to the Outside the Range Alarm with the addition of the initial blocking feature, describe in note below.

Note 1: The action modes 6, 7, 8 and 9 are available to OUTPUT2 only when **ENB** is set to 0 or 3.

Note 2: The **Initial Blocking** causes the controller to disregard alarm situations at the **beginning of the process** when the controller is turned on and starts the control operation.

The Initial Blocking impedes (blocks) the alarm from being switched on in the beginning of the control process. The alarm will only be unblocked after the passage of the variable measured by a non-alarm condition. This feature is useful when, for example, a minimum alarm is programmed in a heating process. Without the blocking, the process would start with an enabled alarm until the control setpoint is achieved.

The output status leds **P1** and **P2** in the instrument panel signal the current action being performed.

OPERATION

The controller requires the internal parameters to be configured according to the intended use for the instrument. The parameters are organized in 4 groups or levels:

Level	Function
0	Measurement
1	Setpoint Adjustment
2	Configuration
3	Calibration

Upon power-up, the controller display shows for 1 second its firmware version. This information is useful when consulting the factory.

Then, the measured input variable is shown on the display. This is the parameter level 0 (measurement level).



To access level 1, press **P** for 1 second until the "SP1" message shows up. Pressing **P** again, the "SP2" parameter is presented. To go back to level 0, press **P** once more.

To access level 2 of parameters, press **P** for 2 seconds until the "rHE" message is shown. Release the **P** key to remain in this level. Each new pressing on the **P** key will advance to the next parameter in the level. At the end of the level, the controller returns to the first level (0).

Use the **▲** and **▼** keys to alter a parameter value.



- Notes:**
- 1 A parameter configuration is saved when the **P** key is pressed to advance to the next parameter in the cycle. The configuration is stored in a non-volatile memory, retaining its value when the instrument is de-energized.
 - 2 If no keyboard activity is detected for over 20 seconds, the controller saves the current parameter value and returns to the measurement level.

Level 1 – Setpoint Adjustment

In this level only the Setpoint (**SP 1** and **SP2**) parameters are available, alternating the names with their respective values. Adjust the desired value for each setpoint clicking on the  and  keys.

SP 1 Set Point 1	Set Point adjustment for control OUTPUT 1. SP 1 value is limited to the values programmed in SPL and SPH in the programming level (Parameter configuration, level 2).
SP2 Set Point 2	Set Point adjustment for control OUTPUT 2. SP2 value is limited to the values programmed in SPL and SPH

Level 2 – Configuration - Parameters configuration Level



Contains the configuration parameters to be defined by the user, according to system requirements. Use  and  keys to set the desired value. The display alternates the parameter name and respective value.

rHE RH - Temp	Defines how the variables, relative humidity and temperature, will be displayed: 0 Relative Humidity 1 Temperature 2 Toggles the indication every 2 seconds. 3 Toggles the indication every 3 seconds. 4 Toggles the indication every 4 seconds. 5 Toggles the indication every 5 seconds. For options 0 and 1 , a fast click on the  key forces the other variable to be displayed for 10 seconds.
Unt Unit	Temperature Unit - Selects display indication for degrees Celsius or Fahrenheit. 0 - Temperature Celsius 1 - Temperature in degrees Fahrenheit
DFH Offset Humidity	RH Offset - Offset value to be added to the displayed relative humidity to compensate for sensor mismatches (when replacing a sensor, for instance). Adjustment range: between -10.0 and 10.0 % of RH. Default value: 0.0
DFt Offset temperature	Temperature Offset - Offset value to be added to the measured temperature to compensate for sensor mismatches. Adjustment range: between -10.0 and 10.0 % of RH. Default value: 0.0
SL 1 SP Low Limit 1	Lower limit value for SP 1 (minimum value with which SP 1 can be configured). SL 1 must be programmed with a lower value than SH 1 .
SH 1 SP High Limit 1	Upper limit for SP 1 (maximum allowed value for SP 1). SH 1 must be programmed with a value higher than the one configured in SL 1 .
SL2 SP Low Limit 2	Lower limit value for SP2 (minimum value with which SP2 can be configured). SL2 must be programmed with a lower value than SH2 .
SH2 SP High Limit 2	Upper limit for SP2 (maximum allowed value for SP 1). SH2 must be programmed with a value higher than the one in SL 1 .
HY 1 Hysteresis 1	OUTPUT 1 Hysteresis : defines the differential range between the input variable value at which the OUTPUT 1 is turned on and the value at which it is turned off. In degrees.
HY2 Hysteresis 2	OUTPUT 2 Hysteresis : defines the differential range between the input variable value at which the OUTPUT 2 is turned on and the value at which it is turned off. In degrees.
RC 1 Action 1	Control action for OUTPUT 1 : 0 Reverse: For heating or humidification. Outputs turn on when variable is lower than SP (See Cnt parameter below). 1 Direct: For cooling or dehumidification. Output turns on when variable is above SP. 2 Low (minimum value) alarm. 3 High (maximum value) alarm. 4 Low alarm with initial blocking. 5 High alarm with initial blocking

RC2 Action 2	Action 2 - Control OUTPUT 2 action or Alarm functions: 0 Reverse control action (heating or humidification). (See Cnt parameter below). 1 Direct control action (cooling or dehumidification). 2 Low (minimum value) alarm. 3 High (maximum value) alarm. 4 Alarm inside the range 5 Alarm outside the range. 6 Low alarm with initial blocking. 7 High alarm with initial blocking. 8 Inside the range alarm with initial blocking. 9 Outside the range alarm with initial blocking. The section Working with the RHT Controller describes how these functions work.
Cnt Control	Assigns the relay for each variable: 0 OUTPUT 1 = RH; OUTPUT 2 = RH; 1 OUTPUT 1 = RH; OUTPUT 2 = Temperature; 2 OUTPUT 1 = Temperature; OUTPUT 2 = RH; 3 OUTPUT 1 = Temperature; OUTPUT 2 = Temperature;
OF 1 Off time 1	Off time 1 - Defines the minimum off time for control OUTPUT 1. Once OUTPUT 1 is turned off, it remains so for at least the time programmed in oF 1 . For thermocouple inputs this parameter is not available. This parameter is intended for refrigeration systems where longer compressor life is desired. For heating systems, program oF 1 to zero. Value in seconds, 0 to 999 s.
On 1 on time 1	On time 1 - Defines the minimum on time for control OUTPUT 1. Once turned on, OUTPUT 1 remains so for at least the time programmed in On 1 . For thermocouple inputs this parameter is not available. This parameter is intended for refrigeration systems where increased compressor life is desired. For heating systems, program on 1 to zero. Value in seconds, 0 to 999 s.
dL 1 Delay 1	Delay 1 - Delay time to start control. Upon power-on, control OUTPUT 1 is kept off until the time programmed in dL 1 is elapsed. Its usage is intended to prevent multiple compressors to start simultaneously after the turn-on of a system with several instruments. Value in seconds, 0 to 250 s.
OF2 Off time 2	Off time 2 - Defines the minimum off time for control OUTPUT 2. Once OUTPUT 2 is turned off, it remains so for at least the time programmed in OF2 . For thermocouple inputs this parameter is not available. This parameter is intended for refrigeration systems where increased compressor life is an issue. For heating systems, program on2 to zero. Value in seconds, 0 to 999 s.
On2 on time 2	On time 2 - Defines the minimum on time for control OUTPUT 2. Once turned on, OUTPUT 2 remains so for at least the time programmed in On2 . For thermocouple inputs this parameter is not available. This parameter is intended for refrigeration systems where increased compressor life is desired. Value in seconds, 0 to 999 s. For heating systems, program OF2 to zero.
dL2 Delay 2	Delay 2 - Delay time for OUTPUT 2 to turn on relative to OUTPUT 1. This parameter defines a particular working mode, typically used in multiple stage systems, where OUTPUT 2 is allowed to go on only if OUTPUT 1 is already on for at least dL2 seconds. Also, OUTPUT 2 is driven off whenever OUTPUT 1 goes off. dL2= 0 disables this function. Value in seconds, 0 to 250 s.
Adr Address	Address – The parameter Adr is presented in instruments loaded with the optional RS485 Modbus RTU communication interface. Set a unique Modbus address for each equipment connected to the network. Address range is from 1 to 247.

Level 3 – Calibration level

The controller is factory adjusted and calibrated using traceable standards. The following parameters should be accessed only by experienced personnel. To enter this cycle, the  key must be kept pressed for 4 seconds.



Don't press the  and  keys if you are not sure of the calibration procedures. Just press the  key a few times until the measurement level is reached again.

PR5	Password - Enter the correct password to unlock write operations for the parameters in the following levels.
CrH	RH Calibration low. Offset calibration for RH.
CtP	T Calibration low. Offset calibration for Temperature.

PrL	Protection - Defines the levels of parameters that will be password protected. See "Configuration Protection" for details.
PRC	Password Change - Allows changing the current password to a new one. Values from 1 to 999 are allowed.
Sn2	Serial number - First part of the electronic serial number of the instrument. This is a read only parameter.
Sn 1	Serial number - Second part of the electronic serial number of the instrument. This is a read only parameter.
Sn0	Serial number - Third part of the electronic serial number of the instrument. This is a read only parameter.

ERROR MESSAGES

Sensor measurement errors force the controller outputs to be turned off. The cause for these errors may have origin in a bad connection, sensor defect (cable or element) or system temperature outside the sensor working range. The display signs related to measurement errors are shown below

	Indicates that: the measurement exceeded the upper level of the sensor range. Possible sensor problem.
	Indicates that: the measurement exceeded the lower level of the sensor range. Possible sensor problem.
	Sensor problem. Revise sensor wiring. If problem persists, contact the factory.

CONFIGURATION PROTECTION

A protection system to avoid unwanted changes to the controller parameters is implemented. The level of protection can be selected from partial to full. The following parameters are part of the protection system:

PR5: When this parameter is presented, the correct password should be entered to allow changes of parameters in the following levels.

PrL: Defines the level of parameters that will be password protected:
 1- Only calibration level is protected (factory configuration);
 2- Calibration and Configuration levels are protected;
 3- All levels are protected - calibration, Configuration and setpoints.

PRC Parameter for definition of a new password. Since it is located in the calibration level, can only be changed by a user that knows the current password. Valid passwords are in the range 1 to 999.

Configuration protection usage

The **PR5** parameter is displayed before entering a protected level. If the correct password is entered, parameters in all following levels can be changed. If wrong or no password is entered, parameters in the following levels will be read only.

Important notes:

- After five consecutive attempts to enter a wrong password, new tentative will be blocked for the next 10 minutes. If the current valid password is unknown, the master password can be used only to define a new password for the controller.
- The factory default password is **111**.

MASTER PASSWORD

The master password allows user to define a new password for the controller, even if the current password is unknown. The master password is based in the serial number of the controller, and calculated as following:

$$[1] + [\text{higher digit of SN2}] + [\text{higher digit of SN1}] + [\text{higher digit of SN0}]$$

for example the master password for the device with serial number 97123465 is: **1 9 3 6**

As follows: **1 + Sn2= 97; Sn 1= 123; Sn0= 465 = 1 + 9 + 3 + 6**

How to use the master password:

- Enter the master password value at **PR5** prompt.
- Go to **PRC** parameter and enter the new password, which must not be zero (0).
- Use this new password.

WARRANTY

Warranty conditions are available on our website www.novusautomation.com/warranty.