



**MODULAR PROCESS CONTROLLER  
N20K48**

USER GUIDE V1.0x A

**NOVUS**  
We Measure, We Control, We Record

---

UK  
CA

FC

**ANATEL**  
00388-21-07089



CE

<b>1</b>	<b>SAFETY ALERTS</b> .....	<b>4</b>
<b>2</b>	<b>INTRODUCTION</b> .....	<b>5</b>
2.1	CONTROLLER .....	5
2.2	CLICKNGO MODULES .....	6
2.3	DOCK.....	6
<b>3</b>	<b>INSTALLATION</b> .....	<b>8</b>
3.1	ELECTRICAL INSTALLATION .....	8
3.1.1	POWER SUPPLY CONNECTIONS.....	8
3.1.2	INPUT CONNECTIONS.....	8
3.1.3	OUTPUT CONNECTIONS.....	9
3.2	PANEL INSTALLATION.....	9
3.3	HOW TO ATTACH THE DOCK TO THE CONTROLLER .....	9
3.4	HOW TO ATTACH A MODULE TO THE DOCK .....	9
3.5	DIMENSIONS .....	10
3.5.1	DIMENSIONS WITH THE DOCK .....	10
<b>4</b>	<b>OPERATION</b> .....	<b>11</b>
4.1	INITIAL OPERATION.....	11
4.1	DISPLAY INFORMATION.....	11
4.2	KEYBOARD.....	11
4.3	ACCESSING CYCLES AND CONFIGURATION PARAMETERS.....	12
4.4	HOW THE DEVICE WILL OPERATE AFTER YOU INSERT A CLICKNGO MODULE.....	13
4.2	FEATURES.....	13
4.2.1	ANALOG INPUT CONFIGURATION .....	13
4.2.2	OUTPUT CONFIGURATION .....	13
4.2.3	ALARM CONFIGURATION .....	14
4.2.3.1	INPUT ERROR TYPES.....	14
4.2.4	ALARM TIMER .....	15
4.2.5	CONTROL MODES .....	15
4.2.6	PID CONTROL MODE AND ON/OFF CONTROL MODE .....	15
4.2.7	INITIAL ALARM BLOCK FUNCTION.....	15
4.2.8	SQUARE ROOT EXTRACTION FUNCTION.....	15
4.2.9	SOFT START FUNCTION .....	16
4.2.10	LOOP BREAK DETECTION (LBD) FUNCTION .....	17
4.2.11	SAFE OUTPUT FUNCTION IN CASE OF SENSOR FAILURE .....	17
4.2.12	TIMERS .....	17
4.3	PARAMETER DESCRIPTION.....	19
4.3.1	OPERATION CYCLE.....	19
4.3.2	CONTROL CYCLE (EFG >> ERL).....	21
4.3.3	ALARM CYCLE (EFG >> RLM) .....	23
4.3.4	INPUT CYCLE (EFG >> IN) .....	25
4.3.5	OUTPUT A CYCLE (EFG >> out .A).....	26
4.3.6	OUTPUT B CYCLE (EFG >> out .b).....	27
4.3.7	MODULES CYCLE (EFG >> Md. 1 or the module number according to its position in the dock) .....	27
4.3.8	PROGRAM CYCLE (EFG >> PRG).....	28
4.3.9	TIMER CYCLE (EFG >> EM).....	30
4.3.10	CALIBRATION CYCLE (EFG >> ERL .ib).....	31
4.4	CONFIGURATION PROTECTION .....	33
4.4.1	PASSWORD .....	33
4.4.2	PASSWORD PROTECTION .....	33
4.4.3	MASTER PASSWORD .....	33
4.5	COMMUNICATION INTERFACES.....	33
4.5.1	USB INTERFACE .....	33

4.5.2	BLUETOOTH INTERFACE.....	33
<b>5</b>	<b>RAMPS AND SOAKS PROGRAMS .....</b>	<b>34</b>
5.1	PROGRAM LINK .....	34
5.2	EVENT ALARM.....	34
<b>6</b>	<b>PID PARAMETERS.....</b>	<b>35</b>
6.1	AUTO-TUNING .....	35
6.2	AUTO-ADAPTATIVE TUNING.....	35
<b>7</b>	<b>CONFIGURATION SOFTWARE.....</b>	<b>37</b>
7.1	QUICKTUNE.....	37
7.2	QUICKTUNE MOBILE .....	37
7.3	CONFIGURING THE DEVICE WITH QUICKTUNE .....	37
7.3.1	BASIC .....	37
7.3.2	FEATURES.....	38
7.3.2.1	ANALOG INPUT .....	38
7.3.2.2	DIGITAL OUTPUT .....	39
7.3.2.3	CONTROL.....	39
7.3.2.4	TUNING .....	40
7.3.2.5	ALARMS .....	41
7.3.2.6	RnS PROGRAMS .....	43
7.3.2.7	TIMER.....	44
7.3.2.8	PROTECTION.....	45
7.3.2.9	GENERAL .....	45
7.3.3	CYCLES.....	46
7.3.3.1	OPERATION .....	46
7.3.3.2	CONTROL.....	46
7.3.3.3	ALARMS .....	47
7.3.3.4	ANALOG INPUT .....	49
7.3.3.5	OUT.A.....	50
7.3.3.6	OUT.B.....	50
7.3.3.7	RnS PROGRAMS .....	51
7.3.3.8	TIMING.....	52
7.3.3.9	CALIBRATION .....	53
7.3.4	FAVORITE .....	53
<b>8</b>	<b>MAINTENANCE .....</b>	<b>54</b>
8.1	CONTROLLER ISSUES .....	54
8.2	INPUT CALIBRATION .....	54
<b>9</b>	<b>SPECIFICATIONS.....</b>	<b>55</b>
9.1	IDENTIFICATION .....	55
9.2	CERTIFICATIONS .....	56
<b>10</b>	<b>WARRANTY.....</b>	<b>57</b>

## 1 SAFETY ALERTS

The symbols below are used in the device and throughout this manual to draw the user's attention to important information related to device safety and use.

		
<b>CAUTION</b> Read the manual fully before installing and operating the device.	<b>CAUTION OR HAZARD</b> Risk of electric shock.	<b>ATTENTION</b> Material sensitive to static charge. Check precautions before handling.

All safety recommendations appearing in this manual must be followed to ensure personal safety and prevent damage to the instrument or system. If the instrument is used in a manner other than that specified in this manual, the device's safety protections may not be effective.

## 2 INTRODUCTION

**N20K48 Modular Controller** brings a new concept of modularity to panel instrumentation.

Traditionally, manufacturers of electronic instrumentation have a wide range of controllers. Each model presents different functionalities, designed to meet the specific requirements of each installation. In the modularity concept applied to **N20K48 Modular Controller**, this is provided in a single controller, which already has a minimum set of features and a basic configuration that can meet several applications.

In addition, you can attach a ClickNGo electronic module, which provide resources such as analog inputs and outputs, digital inputs and outputs, and RS485 communication to the device. The attached modules will be automatically recognized by the controller, which will display the parameters to set the available resources. All modules come with the terminals for electrical connections.

You must use the dock accessory (plastic adapter) to attach the modules to the controller in an easy and quick way. No screws are required.

**N20K48 Modular Controller**, dock, and ClickNGo modules are separate products and must be ordered individually.

The image below shows the elements available in the modularity model adopted by **N20K48 Modular Controller**:

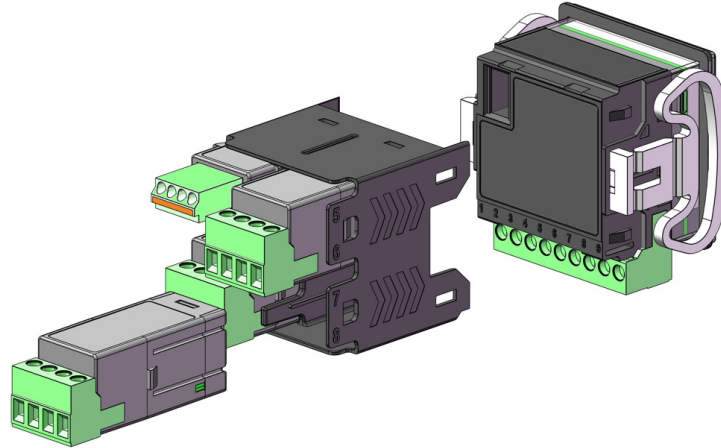

Figure 1 – N20K48 Modular Controller

### 2.1 CONTROLLER

**N20K48 Modular Controller** is a complete and autonomous device. It can control several processes. You can expand its capabilities by attaching ClickNGo electronic modules, which allow it to meet more complex applications.

The device has the following features:

- 1 Universal analog input channel (INPUT)
- 1 Voltage pulse output channel (OUT.A)
- 1 Relay output channel (OUT.B)
- Power supply circuit (POWER)
- HMI with LCD display and keyboard
- Main CPU
- 1 USB port

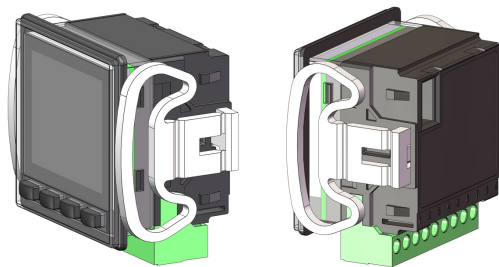

Figure 2 – Device overview

The device has 2 models, differing in relation to the power supply voltage:

- 100~240 Vac/dc power supply model
- 24 Vdc/ac power supply model

You can insert up to 8 ClickNGo modules in your **N20K48 Modular Controller**. The added module will be automatically identified by the controller. The parameters to configure each module will be displayed in the controller configuration cycles (see [MODULES CYCLE](#) section).

## 2.2 CLICKNGO MODULES

The ClickNGo electronic modules extend the **N20K48 Modular Controller** capabilities. They are electrically powered by the controller and have their own connectors. The modules have 3 sizes:

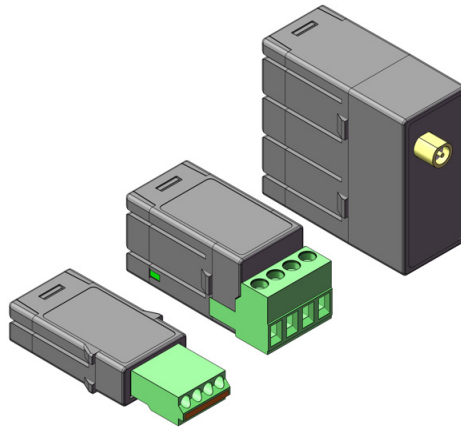

Figure 3 – Sizes

Currently, the following modules are available:

- **ClickNGo CG-2R5 Module:** Provides 2 channels of Relay Output. **Size 2.**
- **ClickNGo CG-3DI Module:** Provides 3 channels of Digital Inputs. **Size 1.**
- **ClickNGo CG-3DO Module:** Provides 3 channels of Voltage Pulse Digital Output. **Size 1.**
- **ClickNGo CG-485 Module:** Provides 1 RS485 Digital Communication channel. **Size 1.**
- **ClickNGo CG-AO Module:** Provides 1 Analog Output channel. **Size 1.**

You can get information about each module on **NOVUS** website.

## 2.3 DOCK

Once attached to the back of the **N20K48 Modular Controller**, the dock allows you to attach electronic modules to the device (see [CLICKNGO MODULES](#) section). It connects electrically to the controller and conducts the electrical control and power supply signals to the electronic modules.

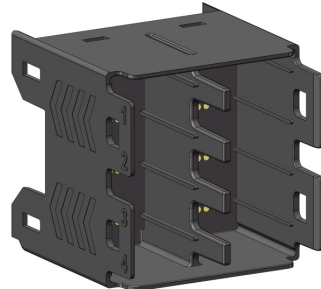

Figure 4 – Accessory dock

The dock is designed to hold up to 8 ClickNGo modules. **Size 1** modules use 1 slot in the dock and a controller with an attached dock can hold up to 8 modules of that size. **Size 2** modules use 2 slots in the dock and a controller with an attached dock can hold up to 4 modules of that size. Size 2 modules can be used in the following positions:

- 1 and 2
- 3 and 4
- 5 and 6
- 7 and 8

You cannot install size 2 ClickNGo modules in pairs of slots 2 and 3 / 6 and 7.

**Size 4** modules use 4 slots in the dock. Thus, **N20K48 Modular Controller** supports only 2 ClickNGo modules of that size.

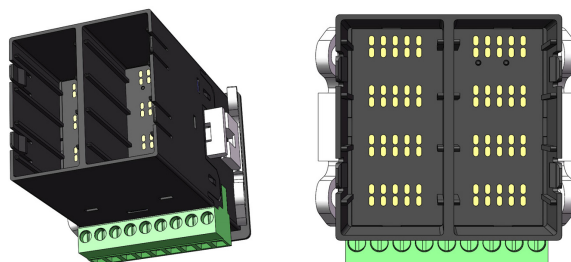

Figure 5 – Dock positions

You can combine modules of different sizes, as shown in the examples below:

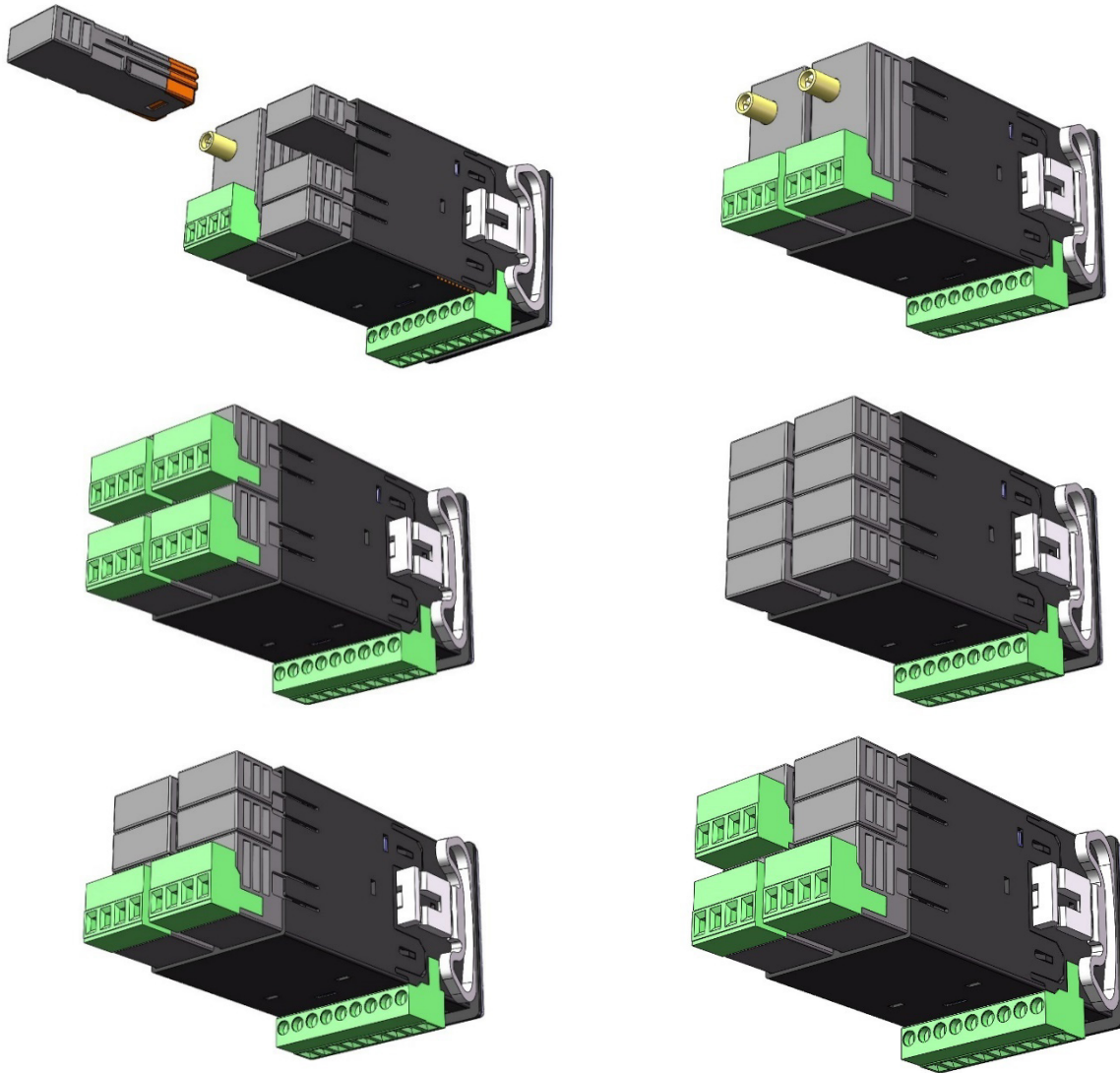

Figure 6 – Modules attached to the dock

### 3 INSTALLATION

#### 3.1 ELECTRICAL INSTALLATION

The figures below reproduce the labels placed on the top of the device and show the disposition of the **N20K48 Modular Controller** resources:

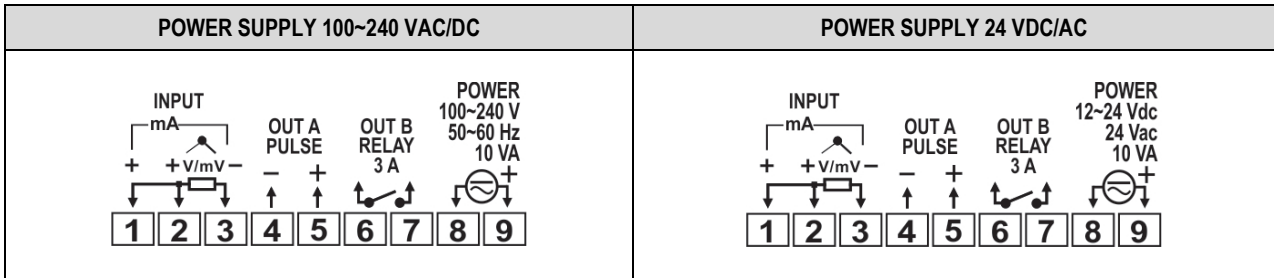

Figure 7 – Electrical connections labels

#### INSTALLATION RECOMENDATIONS

- Electronic and analog signal conductors should run through the plant separately from the output and supply conductors. If possible, in grounded conduits.
- The power supply for electronic instruments must come from a network suitable for instrumentation.
- The use of RC FILTERS (noise suppressors) in contactor coils, solenoids, etc. is recommended.
- In control applications, you must consider what can happen when any part of the system fails. The built-in safety features of the device do not guarantee total protection.
- You must detach the terminal blocks from the device to make the electrical connections. Before you connect them, make sure you have made the correct connections.

#### 3.1.1 POWER SUPPLY CONNECTIONS

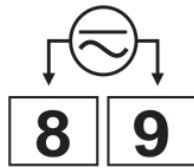

Figure 8 – 100~240 Vac/dc Model

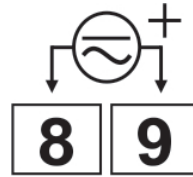

Figure 9 – 24 Vdc/ac Model

\* You must observe the correct polarity of this connection.



In both connections above, it is recommended to use a fuse for terminal 9.

#### 3.1.2 INPUT CONNECTIONS

- **Thermocouples:** Figure 10 shows the connection mode for thermocouple sensors. If you need to extend the thermocouple wires, use appropriate compensating cables.
- **50 mV, 5 V and 10 V:** Figure 11 shows the connection mode for 0-50 mV, 5 V and 10 V.
- **RTD (Pt100):** Figure 12 shows the connection mode for the 3-wire Pt100. You should use conductors of the same gauge and length to compensate for cable length. For 4-wire Pt100, you must leave one conductor disconnected at the controller. For 2-wire Pt100, use short-circuited terminals 1 and 2.
- **0-20 mA and 4-20 mA:** Figure 13 shows the connection mode for current signals.

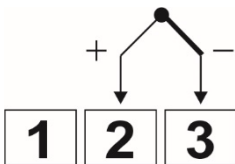

Figure 10 – Thermocouple connection

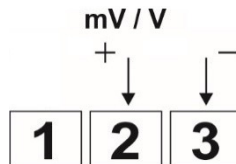

Figure 11 – 50 mV, 5 V and 10 V connections

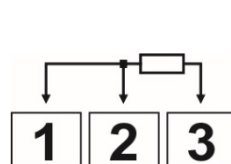

Figure 12 – 3-wire Pt100 connections

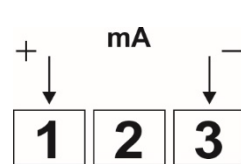

Figure 13 – 0-20 mA and 4-20 mA connections



### 3.1.3 OUTPUT CONNECTIONS

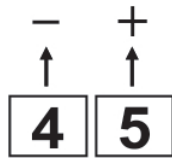

Figure 14 – Output A connection (Voltage Pulse)

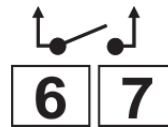

Figure 15 – Output B connection (Relay)

## 3.2 PANEL INSTALLATION

**N20K48 Modular Controller** is suitable for panel installation. You should install it according to the steps below:

- Make a cut-out in the panel as specified in the technical specifications table (see [SPECIFICATIONS](#) chapter).
- Remove the controller fixing clips.
- Insert the controller in the panel.
- Replace the fixing clips on the controller, attaching them as shown in the figure below:

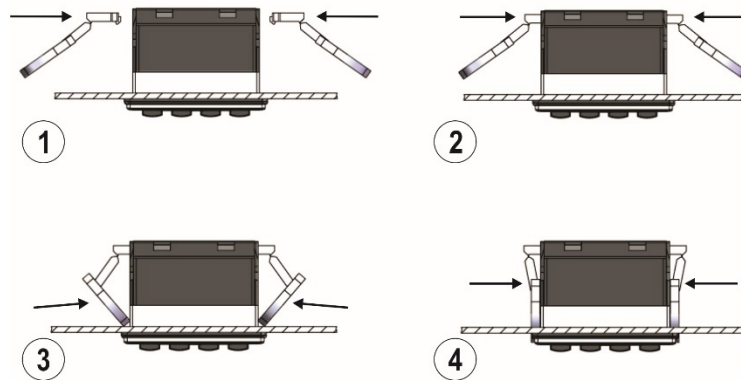

Figure 16 – Fixing clips

## 3.3 HOW TO ATTACH THE DOCK TO THE CONTROLLER

You must attach the dock to the back of the **N20K48 Modular Controller**, as shown in the figure below:

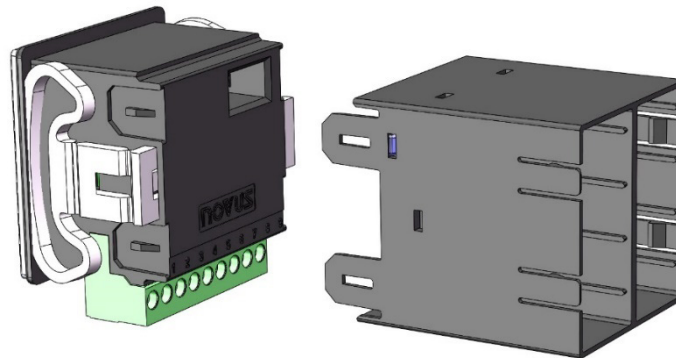

Figure 17 – Attaching the dock to the controller

To attach it to the device, simply press it down until you hear it click into place. To remove it, we recommend using a screwdriver, which can help you release the side locks without damaging the product.

## 3.4 HOW TO ATTACH A MODULE TO THE DOCK

Once you have attached the dock to your device (as shown in the [DOCK](#) section of this chapter), you can add one or more ClickNGo modules to it. To do so, simply insert the module into the dock and press it down until you hear it click into place. If the module is not positioned correctly, it is either not plugged in properly or it has been plugged in at an incorrect position.

You cannot add modules of sizes 2 and 4 between inputs 2 and 3 and inputs 6 and 7. You can use modules of different sizes up to the limit of the dock physical space.



**Before inserting or removing a ClickNGo module, make sure the device has been turned off.**

### 3.5 DIMENSIONS

N20K48 Modular Controller has the following dimensions:

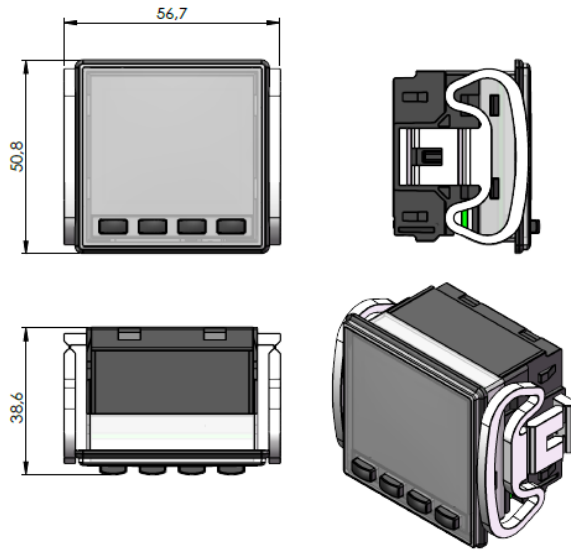

Figure 18 – Dimensions

#### 3.5.1 DIMENSIONS WITH THE DOCK

After you connect the dock to the back of the device, N20K48 Modular Controller will have the following dimensions:

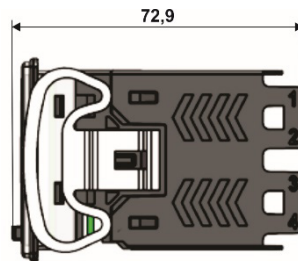

Figure 19 – Device dimensions with the dock

The dock has the following dimensions:

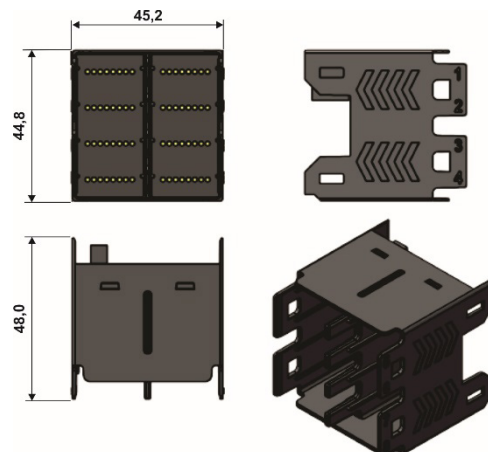

Figure 20 – Device dimensions without the dock

## 4.1 INITIAL OPERATION

After you have completed the electrical installation (see [INSTALLATION](#) chapter) and turned on the device, the **N20K48 Modular Controller** display will show the software version number for the first few seconds. After that, it will display the Indication Screen. It shows the PV (Process Variable) and SP (Setpoint) values and flags that inform specific conditions of the controller and monitored process.

You can see the controller front panel and basic display information in the figure below:

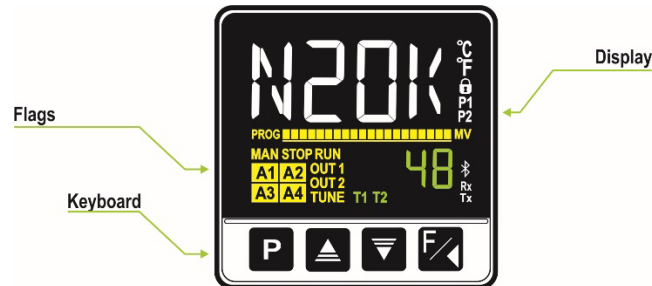

Figure 21 – Front panel

## 4.1 DISPLAY INFORMATION

The **N20K48 Modular Controller** front panel elements are listed below:

- **Main Display:** The Indication screen, in white, displays the PV (Process Variable) value. When in configuration, it shows the identifying symbols (mnemonics) of the parameters that must be set.
- **SP/Parameters Display:** The Indication screen, in green, displays the SP (Setpoint) value. When in configuration, it shows the values set for the various parameters.
- **PROG Flag:** Indicates that a program is running.
- **MAN Flag:** Indicates that the controller is in Manual Control mode (**LER = MAN**).
- **STOP Flag:** Indicates that the control is disabled (**RUN = No**). That is, the device is not in operation.
- **RUN Flag:** Indicates that the control is enabled (**RUN = YES**). That is, the device it is in operation.
- **OUT1 and OUT2 Flags:** Indicates the condition of outputs A and B.
- **TUNE Flag:** Indicates that an Auto-tuning process is in progress.
- **A1, A2, A3 and A4 Flags:** Indicates that there are alarm events.
- **°C Flag:** Indicates that the temperature measurement was set in Celsius.
- **°F Flag:** Indicates that the temperature measurement was set in Fahrenheit.
- **🔒 Flag:** Indicates that configuration protection is enabled.
- **T1 and T2 Flags:** Indicates that there is a timer configured.
- **Bluetooth Flag:** Indicates that the controller is connected to the **QuickTune Mobile** application.
- **Rx/Tx Flags:** Flashes whenever the controller exchanges data with the communication network.

## 4.2 KEYBOARD

The **N20K48 Modular Controller** front panel has the following keys:

- **P Key:** Key used to advance the parameters and parameter cycles.
- **▲ and ▼ Keys:** Keys used to increment and decrement values. Used to change parameter values and/or condition.
- **⏮ Key:** Key used to regress the parameters during setup and, when available, to perform special functions.

### 4.3 ACCESSING CYCLES AND CONFIGURATION PARAMETERS

**N20K48 Modular Controller** has configuration parameters, which have been gathered into affinity groups, called Cycles. As shown in the figure below, there is the **Operation Cycle** and the **Configuration Cycles**, composed of Control, Alarms, Input, Output A, Output B, Modules (1 to 8), Programs, Timer, and Calibration:

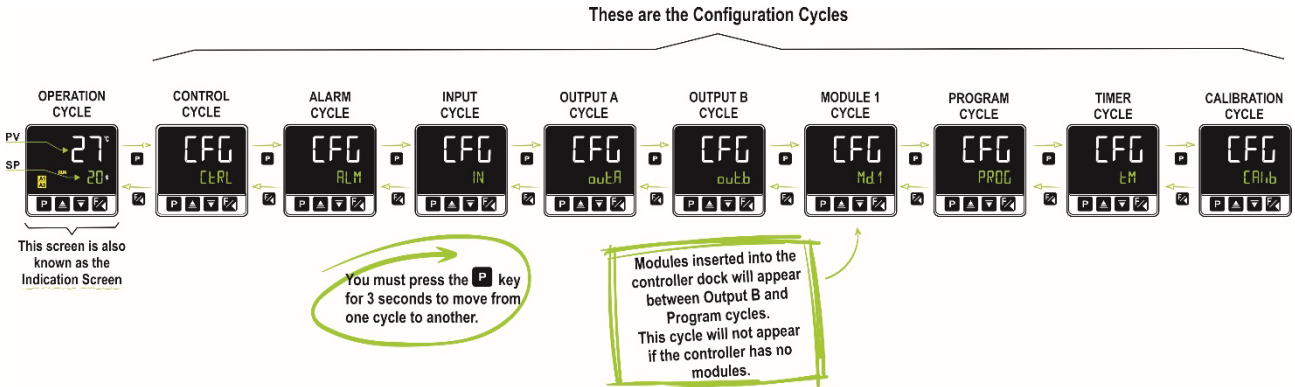

Figure 22 – N20K48 Cycles

To navigate between cycles, as shown in the figure above, you must press the **P** key for three seconds. Once in the desired cycle, simply click the **P** key until you find the parameter that you want to configure. You must use the **▲** or **▼** keys to change the condition/value of the desired parameter.

In either case, the **↶** key allows you to go back.

To view the parameters of each cycle, please refer to the following figure:



Figure 23 – Cycles and parameters groups

The figure above shows the controller parameters, which does not mean that all of them will always be displayed. Some settings are mutually exclusive, and some parameters are only displayed during certain situations. If the **N20K48 Modular Controller** does not display the desired parameter, you should observe the instructions in the [FEATURES](#) and [PARAMETER DESCRIPTION](#) sections.

According to the configuration protection configured, the controller will ask for the protection password whenever there is an attempt to enter the parameter cycles. For more information, see [CONFIGURATION PROTECTION](#) section, which describes this functionality.

The controller settings are stored in protected electronic memory. This information will not be erased if there is a power outage, for example. The settings made in each parameter will be saved when you move to the next parameter or step back to the previous parameter. The value of the SP parameter will automatically be saved (with or without change) every 25 seconds.

#### 4.4 HOW THE DEVICE WILL OPERATE AFTER YOU INSERT A CLICKNGO MODULE

Once you have inserted the dock into the device, the ClickNGo module will be recognized when the device is powered up. You can use the instructions above to navigate through the parameter cycles and access the settings of the added ClickNGo module.

The settings of the added module will be available according to its position in the dock. A ClickNGo module inserted in position 1, for example, will be viewable within the Configuration Cycle (**CFG**), in the Module 1 Cycle (**CFG >> Md. 1**).

Once a module is removed from the dock, it will no longer be recognized by the device and the settings made will be lost.

You can see the specific information of each module in its respective datasheet, available on the device web page.

	<b>Before inserting or removing a ClickNGo module to the dock, please verify that the device is turned off.</b>
---	---

## 4.2 FEATURES

This section introduces the **N20K48 Modular Controller** features. To learn more about each parameter, see [PARAMETER DESCRIPTION](#) section.

### 4.2.1 ANALOG INPUT CONFIGURATION

This is the first configuration to be set in the **N20K48 Modular Controller**. You can select the input type in the **TYPE** parameter (**CFG >> IN >> TYPE**) and according to the options available below:

TYPE	CODE	MEASUREMENT RANGE
J	<b>tc J</b>	Range: -110 to 950 °C (-166 to 1742 °F)
K	<b>tc K</b>	Range: -150 to 1370 °C (-238 to 2498 °F)
T	<b>tc t</b>	Range: -160 to 400 °C (-256 to 752 °F)
N	<b>tc N</b>	Range: -270 to 1300 °C (-454 to 2372 °F)
R	<b>tc R</b>	Range: -50 to 1760 °C (-58 to 3200 °F)
S	<b>tc S</b>	Range: -50 to 1760 °C (-58 to 3200 °F)
B	<b>tc b</b>	Range: 400 to 1800 °C (752 to 3272 °F)
E	<b>tc E</b>	Range: -90 to 730 °C (-130 to 1346 °F)
Pt100	<b>Pt</b>	Range: -200 to 850 °C (-328 to 1562 °F)
0-20 mA	<b>LD.20</b>	Analog Linear Signal Programmable indication from -1999 to 9999.
4-20 mA	<b>LY.20</b>	
0-50 mV	<b>LD.50</b>	
0-5 Vcc	<b>LD.5</b>	
0-10 Vcc	<b>LD.10</b>	

Table 1 – Input types

All input types are factory calibrated.

### 4.2.2 OUTPUT CONFIGURATION

**N20K48 Modular Controller** has 2 native output channels: **out.R** and **out.b** (**CFG >> out.R** or **CFG >> out.b**), which accept the following configurations:

SCREEN	FUNCTION	ACTION
<b>oFF</b>	No function	The output configured with this option will not be used by the controller.
<b>MV 1</b>	Control Output 1	The output will act as control output 1.
<b>MV 2</b>	Control Output 2	The output will act as control output 2.
<b>R 1</b>	Alarm Output 1	The output will act as alarm output 1.
<b>R2</b>	Alarm Output 2	The output will act as alarm output 2.
<b>R3</b>	Alarm Output 3	The output will act as alarm output 3.
<b>R4</b>	Alarm Output 4	The output will act as alarm output 4.
<b>t 1</b>	Timer 1	The output will act as timer output 1.

<b>E2</b>	Timer 1	The output will act as alarm output 2.
<b>M.Coil</b>	Modbus-Coil	The output will act as a Modbus-Coil command for connection to the Modbus-TCP protocol.

**Table 2 –** Function types for analog outputs

You can add more outputs to the device by adding more modules (see [CLICKNGO MODULES](#) section).

### 4.2.3 ALARM CONFIGURATION

**N20K48 Modular Controller** has 4 independent alarms (**CFG >> ALM >> Fu.A1, Fu.A2, Fu.A3 or Fu.A4**), which can be configured to operate with the following functions:

SCREEN	FUNCTION	ACTION
<b>oFF</b>	Disabled	The alarm is off.
<b>Lo</b>	Minimum Value Alarm (Low)	
<b>Hi</b>	Maximum Value Alarm (High)	
<b>dIF</b>	Differential Value Alarm (Differential)	<div style="display: flex; justify-content: space-around;"> <div style="text-align: center;"> <p><b>Positive SPAN</b></p> </div> <div style="text-align: center;"> <p><b>Negative SPAN</b></p> </div> </div>
<b>dIF.L</b>	Differential Minimum Value Alarm (Differential Low)	<div style="display: flex; justify-content: space-around;"> <div style="text-align: center;"> <p><b>Positive SPAN</b></p> </div> <div style="text-align: center;"> <p><b>Negative SPAN</b></p> </div> </div>
<b>dIF.H</b>	Differential Maximum Value Alarm (Differential High)	<div style="display: flex; justify-content: space-around;"> <div style="text-align: center;"> <p><b>Positive SPAN</b></p> </div> <div style="text-align: center;"> <p><b>Negative SPAN</b></p> </div> </div>
<b>uErr</b>	Input Error (input Error)	Function to detect input errors, although not all admitted input error can be identified by this function. See section <a href="#">INPUT ERROR TYPES</a> . This option and the <b>Initial Alarm Block</b> function are mutually exclusive. You cannot set an initial block if you set up an alarm as Open Sensor Alarm.
<b>rS</b>	Event Alarm (ramp and Soak)	The alarm must be triggered in specific segments of the Ramps and Soaks programs to be created. See <a href="#">RAMPS AND SOAKS PROGRAMS</a> chapter.
<b>End.t</b>	End of Soak (End of Level)	End of Ramp to Soak program time. Allows the controller to go into alarm upon reaching the set Ramp to Soak time.
<b>Lbd</b>	Loop Break Detection	Allows you to set the selected channel as output for the Loop Break Detector function.

**Table 3 –** Alarm functions

In the above examples, the term SPAn refers to the following Alarm Setpoints: **SP.A1, SP.A2, SP.A3** and **SP.A4**.

Alarms configured with **Hi**, **dIF** and **dIF.H** functions also trigger the related output when the controller identifies a sensor failure. A relay output, for example, configured to behave as a Maximum Alarm (**Hi**), will act when the SPAL value is exceeded and when the sensor connected to the controller input breaks.

If no control output is used, both outputs can be set as alarms (see [OUTPUT CONFIGURATION](#) section).

#### 4.2.3.1 INPUT ERROR TYPES

The **Input Error** function cannot identify all types of errors. A short-circuit in the 0-5 V input signal, for example, will be identified by the device as a 0 V signal applied to the input and thus will be recognized as a valid value. In such situations, you should analyze each case.

The table below shows the behavior of the controller when facing possible failures allowed for the various types of input:

INPUT TYPE	PROBLEM	PROBLEM DESCRIPTION
Thermocouple	Open or broken thermocouple	The error will be recognized by the <b>Input Error</b> function. In its display, the device will show the <b>UUUU</b> message.
	Short Circuit	The error will <b>not</b> be recognized by the <b>Input Error</b> function. In its display, the device will show the temperature value of its rear terminals (Cold Junction temperature).
Pt100	Broken wires	The error will be recognized by the <b>Input Error</b> function. In its display, the device will show the <b>----</b> message.
	Short Circuit	The error will be recognized by the <b>Input Error</b> function. In its display, the device will show the <b>UUUU</b> message.
0-20 mA	Broken or short-circuited wiring	The error will <b>not</b> be recognized by the <b>Input Error</b> function. In its display, the equipment will show the lower value of the configured range.

INPUT TYPE	PROBLEM	PROBLEM DESCRIPTION
4-20 mA	Broken or short-circuited wiring	The error will be recognized by the <b>Input Error</b> function. In its display, the device will show the - - - - message.
0-5 V 0-10 V	Broken or short-circuited wiring	The error will <b>not</b> be recognized by the <b>Input Error</b> function. In its display, the equipment will show the lower value of the configured range.
0-50 mV	Broken wires	The error will be recognized by the <b>Input Error</b> function. In its display, the device will show the - - - - message.
	Short Circuit	The error will <b>not</b> be recognized by the <b>Input Error</b> function. In its display, the equipment will show the lower value of the configured range.

Table 4 – Input error types

#### 4.2.4 ALARM TIMER

The alarm can be triggered in the following ways:

- Defined time alarm trigger
- Delayed alarm trigger
- Intermittent alarm trigger

The table below shows the behavior of the alarm outputs with the trigger variations defined by the time ranges T1 and T2, available in parameters  $E_{1A1}$ ,  $A_{E2A1}$ ,  $E_{1A2}$ ,  $E_{2A2}$ ,  $E_{1A3}$ ,  $E_{2A3}$ ,  $E_{1A4}$  and  $E_{2A4}$  (CFG >> ALM >>  $E_{1A1}$  or the desired timer parameter T1 or T2).

OPERATION	T 1	T 2	ACTION
Normal operation	0	0	
Defined time alarm trigger	1 to 6500 s	0	
Delayed alarm trigger	0	1 to 6500 s	
Intermittent alarm trigger	1 to 6500 s	1 to 6500 s	

Table 5 – Alarm timer functions

The alarm indicators light whenever an alarm condition occurs, regardless of the alarm output status (see [DISPLAY INFORMATION](#) section).

#### 4.2.5 CONTROL MODES

**N20K48 Modular Controller** has 2 control modes: Automatic mode or Manual mode, as configured in the  $C_{Er}$  parameter of the Operation Cycle (see [OPERATION CYCLE](#) section).

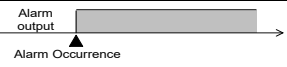
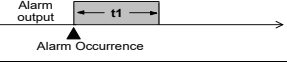
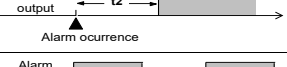
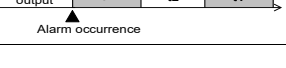
- In Automatic mode ( $C_{Er}$  >>  $A_{uLo}$ ), the controller sets the MV value to be applied to the process. It is based on the parameters set (SP, PID, etc.).
- In Manual mode ( $C_{Er}$  >>  $M_{AN}$ ), you need to set this value.

#### 4.2.6 PID CONTROL MODE AND ON/OFF CONTROL MODE

The Automatic control mode ( $C_{Er}$  >>  $A_{uLo}$ ) has 2 control strategies: PID control and ON/OFF control.

- In PID control mode, the PID control action is based on a control algorithm that acts on the deviation of the PV value from the SP value and based on the set  $P_b$ ,  $I_r$  and  $dE$  parameters. To configure this control mode, you must set the  $P_b$  parameter to a value other than 0.
- In ON/OFF control mode, the controller must act with 0 % or 100 % power when the PV deviates from the SP value. To configure this control mode, you must set the  $P_b$  parameter to a value other than 0 (Once this is done, the parameters  $I_r$  and  $dE$  will not be displayed).

For more information about the parameters  $P_b$ ,  $I_r$  and  $dE$ , see [CONTROL CYCLE](#) section.

#### 4.2.7 INITIAL ALARM BLOCK FUNCTION

The **Initial Alarm Block** function (CFG >> ALM >>  $bL.A1$ ,  $bL.A2$ ,  $bL.A3$  or  $bL.A4$ ) prevents the alarm from being triggered during an alarm condition when the controller is on or after the operation transition (RUN >>  $n_o \rightarrow YES$ ). The alarm will be enabled after the process goes through a non-alarm condition.

The initial block is useful when one of the alarms is set as a minimum value alarm (CFG >> ALM >>  $F_{u,A1}$  or the desired alarm number >>  $L_o$ ), for example. This may cause the alarm to be triggered during process startup (a behavior that is often undesired).

The initial block is not valid for the Open Sensor Alarm function (For more information about this and other types of alarms, see table in [ALARM CONFIGURATION](#) section).

#### 4.2.8 SQUARE ROOT EXTRACTION FUNCTION

Once this function is enabled (CFG >> IN >>  $SQR_E$ ), the controller will display the value corresponding to the square root of the applied input signal. Available only for the following **analog linear signal** input: 0-20 mA, 4-20 mA, 0-50 mV, 0-5 V and 0-10 V (see [ANALOG INPUT CONFIGURATION](#) section).

#### 4.2.9 SOFT START FUNCTION

The **Soft Start** function (**CFG >> ERL >> SF.SL**) prevents abrupt variations in the power delivered to the load by the controller control output. A time interval (in seconds) limits the rise in the percentage of power delivered to the load. It will only reach 100 % of the power at the end of this interval.

This function is normally used in processes that require a slow start, where applying 100% power to the load instantaneously can damage parts of the process.

Available only when in PID control mode (see [PID CONTROL MODE AND ON/OFF CONTROL MODE](#) section).



#### 4.2.10 LOOP BREAK DETECTION (LBD) FUNCTION

The **Loop Break Detection** function (**CFG >> ALM >> Lbd.E**) allows you to set a maximum time interval (in minutes) for the PV to react to the control output command. If the PV does not react minimally and adequately within this interval, **N20K48 Modular Controller** signals the occurrence of an LBD event on its display (i.e., problems in the control loop).

You can also address the LBD event to one of the controller alarms. To do this, simply set the desired alarm with the **Ldb** function. When the configured event occurs (**CFG >> ALM >> Fu.A1, Fu.A2, Fu.A3** or **Fu.A4 >> Ldb**), the respective output will be activated (see [ALARM CONFIGURATION](#) section).

This function is disabled if configured with 0 (zero).

This function allows the device to detect problems in the installation, such as a defective actuator, a failure in the load power supply, or an open sensor. Even in these cases, the **Ldb** function will signal the occurrence of an LBD event after the time interval you have set has elapsed.

#### 4.2.11 SAFE OUTPUT FUNCTION IN CASE OF SENSOR FAILURE

With this function, the control output will enter a safe condition for the process whenever there is an error at the input (sensor). When identifying a failure, the controller will apply to MV the percentage value that was set in the **IE.ov** parameter (**CFG >> CLR.L**).

If the **IE.ov** parameter has been set to 0.0 (zero), this function will be disabled, and the control output will be switched off whenever occurs a failure at the input.

#### 4.2.12 TIMERS

The controller has 2 timers (**T1** and **T2**), which operate independently of the process control. The parameters that define the operating mode of these timers are listed in the Timer Cycle (**CFG >> TM**). Any of the controller outputs can be linked to the timers.

Time counting always starts from T1. The device starts counting from T2 at the end of this count.

In parameter **E.tb** you can define whether the time base will be in HH:MM (hours and minutes) or in MM:SS (minutes and seconds).

The parameter **E.RUN** allows the process control to be disabled at the end of the timers.

The flags T1 and T2 are displayed on the front of the controller and refer to the status of the T1 and T2 timers (see [DISPLAY INFORMATION](#) section).

#### T1 TIMER

T1 is the main timer. You can define its operation by setting 2 parameters:



**E.Str** Timer trigger mode

**E.End** Output behavior during timer process

If you set parameter **E.1.E**, T1 parameter will be displayed in the Operation Cycle.

#### T1 TIMER TRIGGER

You can set Timer 1 in parameter **E.Str**:

<b>E.Str</b> <i>Timer Start</i>	<p>Allows you to set T1 timer start/stop mode.</p> <p><b>oFF</b> Timers are off (T1 and T2). The parameters related to the timer will not be displayed.</p> <p><b>SP</b> Starts counting T1 when the PV value reaches the SP value defined for the process.</p> <p><b>F</b> Starts counting T1 by pressing the  key.</p> <p>Once the timer has started, you can interrupt it by briefly pressing the  key (1 s). Another short press will resume the timer. A long press of the  key (3 s) immediately ends the timer cycle in progress.</p> <p><b>RUN</b> Starts counting when control is enabled (<b>RUN &gt;&gt; YES</b>).</p> <p><b>d i</b> Triggers with digital input.</p>
------------------------------------	---

The control must be enabled (**RUN= YES**) before you can trigger the timer by pressing the  key.

#### OUTPUT T1 BEHAVIOR DURING T1

The output T1 can behave in 2 ways during T1 timer:

<b>E.End</b> <i>Timer End</i>	<p>T1 output behavior at the end of T1 timer.</p> <p><b>on</b> T1 output is <b>on (on)</b> at the end of T1. At the start of T1 timer, the T1 output remains off. At the end of the timer, the T1 output is on and remains in this condition until a new cycle starts.</p> <p>The T1 flag flashes during T1 timer. It switches on permanently after T1 has elapsed, indicating that the output is still on.</p> <p><b>oFF</b> T1 output is <b>off (oFF)</b> at the end of T1 interval.</p> <p>In this mode, T1 is on when T1 timer starts, and is off at the end of T1 timer.</p> <p>The T1 flag flashes during T1 timer and definitively switches off at the end of T1.</p>
----------------------------------	--

On the controller front panel, the **T1** flag indicates the timer status.

In both cases, the respective flag (T1 or T2) will flash rapidly whenever the timer is interrupted by pressing the key .

## PROCESS CONTROL BEHAVIOR AT TIMING END

During T1 and T2 intervals, the process control acts as it has been configured. However, at the end of the T1 + T2 interval, you can set the controller to disable process control (**RUN** >> **NO**). In Cycle Timer (**CFG** >> **EM**), the parameter **E.RUN** allows you to determine the desired setting:

<b>E.RUN</b> <i>Timer Run</i>	Allows you to define the behavior of the process control at the end of <b>T1 + T2</b> . <b>ON</b> Temperature control continues to operate. <b>OFF</b> Disables control at the end of the timer ( <b>RUN = NO</b> ).
----------------------------------	--

## T2 TIMER

T2 is the secondary timer. It always starts at the end of T1. It can also be linked to any output available in the controller. The linked output turns on at the beginning of T2 and turns off at the end of T2.

The **T2** flag indicates the T2 timer condition (see [DISPLAY INFORMATION](#) section):

- T2 in progress = The T2 flag is flashing.
- T2 not started or already ended = The T2 flag is off.

## TIMING DIRECTION

The time counting of the 2 timers (T1 and T2) can occur in forward or backward mode. In the forward mode (**UP**), counting starts from 0 and goes up to the programmed time interval value (T1, T2). In backward mode (**DN**), counting starts at the value of the set time interval and counts down to 0. The timing direction is set in parameter **E.dir**:

<b>E.dir</b> <i>Timer Direction</i>	<b>T1</b> timing count direction. <b>UP</b> Forward mode, starting at 0. <b>DN</b> Backward mode.
--	---

### 4.3 PARAMETER DESCRIPTION

**N20K48 Modular Controller** has cycles, composed of configuration parameters that have been grouped into affinity groups. The tables below present detailed information about each device cycle.

#### 4.3.1 OPERATION CYCLE

This is the Operation Cycle:

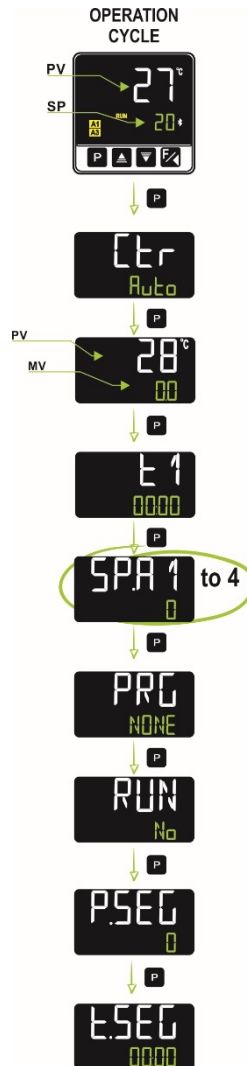

Figure 24 – Operation Cycle

The Operation Cycle is also called **Indication Screen** and has the following parameters:

<div style="border: 1px solid black; padding: 2px; margin-bottom: 2px;">PV Indication (White display)</div> <div style="border: 1px solid black; padding: 2px;">SP Indication (Green display)</div>	<p><b>PV and SP Indication Screen.</b> The upper display indicates the current value of PV. The lower display indicates the value of the adopted control SP.</p>
<div style="border: 1px solid black; padding: 2px; margin-bottom: 2px;">E1 Control</div>	<p><b>Control Mode:</b>  <b>Auto</b> – Automatic control mode  <b>MAN</b> – Manual control mode          Bumpless transfer between automatic and manual.          You must set the parameter Enable Control Function (<b>E1.E</b>) of the Calibration Cycle (<b>CAL 1b</b>) to <b>YES</b> or <b>no</b> to display this parameter in the Operation Cycle.</p>
<div style="border: 1px solid black; padding: 2px; margin-bottom: 2px;">PV Indication (White display)</div> <div style="border: 1px solid black; padding: 2px;">MV Indication (Green Display)</div>	<p><b>MV Value.</b> The upper display indicates the value of PV. The lower display indicates the percentage value applied to the control output (MV).          In Automatic control mode, you can only view the MV value. In Manual control mode, you can change the MV value. See <a href="#">CONTROL MODES</a> section.          To distinguish this screen from the SP screen, the MV value flashes constantly.</p>
<div style="border: 1px solid black; padding: 2px; margin-bottom: 2px;">E1 Timer 1</div>	<p>Timer 1. Allows you to set a value for timer 1.          You must set the parameter Enable Timer 1 (<b>E1.E</b>) of the Timer Cycle (<b>EM</b>) to <b>YES</b> or <b>no</b> to display this parameter in the Operation Cycle.</p>

<p><b>PRG</b> <i>Program</i></p>	<p>Program execution. Allows you to select the Ramps and Soaks program to be executed.</p> <p><b>NONE</b> – Do not execute any program  <b>1 to 20</b> – Number of the program to be executed</p> <p>With the outputs enabled (<b>RUN = YES</b>), the selected program will be executed immediately.</p> <p>You must set the parameter Enable Program Function (<b>PRG.E</b>) of the Timer Cycle (<b>TM</b>) to <b>YES</b> or <b>no</b> to display this parameter in the Operation Cycle.</p>
<p><b>SP.A1</b> <b>SP.A2</b> <b>SP.A3</b> <b>SP.A4</b> <i>Setpoint Alarm</i></p>	<p>Alarm SP. Allows you to define the actuation point for alarms programmed with <b>Lo</b> or <b>Hi</b> functions.</p> <p>This parameter defines the deviation of alarms programmed with <b>Differential</b> type functions.</p> <p>This parameter is not used for other alarm functions.</p> <p>You must set the parameter for the desired Alarm Setpoint (<b>E.SPA1</b>, <b>E.SPA2</b>, <b>E.SPA3</b> or <b>E.SPA4</b>) of the Alarm Cycle (<b>ALM</b>) to <b>YES</b> or <b>no</b> to display the Alarm Setpoint parameters in the Operation Cycle.</p>
<p><b>P.SEG</b> <i>Program Segment</i></p>	<p>Indicative screen only. When a program is running, displays the number of the running segment of this same program.</p>
<p><b>E.SEG</b> <i>Time Segment</i></p>	<p>Indicative screen only. When a program is running, displays the time left to finish the running segment. Displayed in the time unit adopted in the Programs Time base parameter (<b>CFG &gt;&gt; PROG &gt;&gt; Pr.Eb</b>).</p>
<p><b>RUN</b></p>	<p>Allows you to enable control outputs and alarms.</p> <p><b>YES</b> – Enabled  <b>No</b> – Disabled</p> <p>You must set the parameter Enable Function RUN (<b>RUN.E</b>) of the Calibration Cycle (<b>CAL Ib</b>) to <b>YES</b> or <b>no</b> to display this parameter in the Operation Cycle.</p>

Table 6 – Operation cycle

### 4.3.2 CONTROL CYCLE (CFG >> CLR)

This is the Control Cycle:



Figure 25 – Control mode

This cycle allows you to configure the parameters that refer to the control mode and the device tuning process. See [PID PARAMETERS](#) chapter for more information about PID control and tuning processes.

<p><b>Atun</b> <i>Auto-tune</i></p>	<p>Allows you to define the tuning mode to be used:</p> <ul style="list-style-type: none"> <li>oFF – Disabled</li> <li>FAST – Fast auto-tuning</li> <li>FULL – Precise auto-tuning</li> <li>SELF – Precise + auto-adaptive tuning</li> <li>rSLF – Forces a new precise + auto-adaptive auto-tuning</li> <li>EGHE – Forces a new precise + auto-tuning when RUN = YES or when the controller is on</li> </ul>
<p><b>Pb</b> <i>Proportional Band</i></p>	<p>Proportional Band. Value of the P term of the PID control mode, in percent of the input type maximum range. Adjustable between 0 and 500.0 %.</p> <p><b>When set to 0.0 (zero), determines the ON/OFF control mode.</b></p>
<p><b>Ir</b> <i>integral rate</i></p>	<p>Integral Rate. Value of the I term of the PID control mode, in repetitions per minute (Reset). Adjustable between 0 and 99.99.</p> <p>This parameter is displayed if the <b>Proportional Band</b> is ≠ 0.</p>

<b>dE</b> <i>derivative time</i>	Derivative Time. Value of the <b>D</b> term of the PID control mode, in seconds. Adjustable between 0 and 300.0 seconds. This parameter is displayed if the <b>Proportional Band</b> is $\neq 0$ .
<b>CE</b> <i>cycle time</i>	PWM Cycle Time. Value in seconds of the PWM cycle period of the PID control. Adjustable between 0.5 and 100.0 seconds. This parameter is displayed if the <b>Proportional Band</b> is $\neq 0$ .
<b>HYSL</b> <i>Hysteresis</i>	Control hysteresis. Hysteresis value for Control ON/OFF mode. Adjustable between 0 and the measurement range width of the selected input type. This parameter is displayed only for Control ON/OFF mode ( <b>Pb</b> = 0).
<b>Act</b> <i>Action</i>	Control Logic. Only for Automatic control mode ( <b>CEr</b> >> <b>AutO</b> ). <b>rE</b> – Reverse action control. Suitable for <b>heating</b> . Turns on the control output when PV is below SP. <b>dIr</b> – Direct action control. Suitable for <b>cooling</b> . Turns on the control output when PV is above SP.
<b>SF.SL</b> <i>Soft Start</i>	Soft Start function. Time interval (in seconds) during which the controller limits the control output rise rate (MV). Adjustable between 0 and 9999 seconds. This parameter is displayed if the <b>Proportional Band</b> is $\neq 0$ .
<b>bAS</b>	Bias function. Allows you to change the percentage value of the control output (MV) by adding a value between -100 % and +100 %. This parameter is displayed if the <b>Proportional Band</b> is $\neq 0$ .
<b>SP.LL</b> <i>Setpoint Low Limit</i>	Allows you to set the lower limit to adjust the SP value. Allows you to set the minimum value of the PV indication range and limit the SP adjustment for the available <b>linear analog inputs</b> (0-20 mA, 4-20 mA, 0-50 mV, 0-5 V and 0-10 V).
<b>SP.HL</b> <i>Setpoint High Limit</i>	Allows you to set the upper limit to adjust the SP value. Allows you to set the maximum value of the PV indication range and limit the SP adjustment for the available <b>linear analog inputs</b> (0-20 mA, 4-20 mA, 0-50 mV, 0-5 V and 0-10 V).
<b>ouLL</b> <i>output Low Limit</i>	Lower limit for the control output. Allows you to set the minimum percentage value of the control output when it is set in Automatic control mode ( <b>CEr</b> >> <b>AutO</b> ) and in PID (parameter <b>Pb</b> $\neq 0$ ). Typically set to 0.0 %.
<b>ouHL</b> <i>output High Limit</i>	Upper limit for the control output. Allows you to set the maximum percentage value of the control output when it is set in Automatic control mode ( <b>CEr</b> >> <b>AutO</b> ) and in PID (parameter <b>Pb</b> $\neq 0$ ). Typically set to 100.0 %.
<b>iE.ou</b> <i>input Error output</i>	Output value (MV1) when the controller identifies an input error.

Table 7 – Control cycle

### 4.3.3 ALARM CYCLE (CFG >> ALM)

This is the Alarm Cycle:



Figure 26 – Alarm cycle

<p>Fu.A1 Fu.A2 Fu.A3 Fu.A4 <i>Function Alarm</i></p>	<p>Alarm functions. Allows you to define the alarms functions:</p> <ul style="list-style-type: none"> <li>oFF – Disabled</li> <li>Lo – Minimum value alarm</li> <li>Hi – Maximum value alarm</li> <li>dIF – Differential value alarm</li> <li>dIF.L – Minimum differential value alarm</li> <li>dIF.H – Maximum differential value alarm</li> <li>uErr – Open sensor alarm</li> <li>rS – Event alarm</li> <li>End.t – End of Ramp</li> <li>Lbd – Loop Break Detection</li> </ul> <p>See table in <a href="#">ALARM CONFIGURATION</a> section.</p>
<p>SP.A1 SP.A2 SP.A3 SP.A4 <i>Setpoint Alarm</i></p>	<p>Alarm SP. Allows you to define the actuation point for alarms programmed with Lo or Hi functions. This parameter defines the deviation of alarms programmed with <b>Differential</b> type functions. This parameter is not used for other alarm functions.</p>

<b>bL.A1</b> <b>bL.A2</b> <b>bL.A3</b> <b>bL.A4</b> <i>Blocking Alarm</i>	<p>Initial Alarm Block. Allows you to enable or disable the Initial Block function for alarms 1 to 4.</p> <p><b>YES</b> – Enables initial block  <b>No</b> – Disables initial block</p> <p>When enabled, the alarm will not trigger during startup. It will wait until the PV value enters a non-alarm condition. From this point on, the alarm can be triggered if a new alarm condition occurs.</p>
<b>HY.A1</b> <b>HY.A2</b> <b>HY.A3</b> <b>HY.A4</b> <i>Hysteresis of Alarm</i>	<p>Alarm hysteresis. Allows you to define the difference between the PV value at which the alarm is on and the value at which it is off.</p> <p>One hysteresis value for each alarm.</p>
<b>Lbd.1</b> <b>Lbd.2</b> <b>Lbd.3</b> <b>Lbd.4</b> <i>Loop break detection</i>	<p>Loop Break Detection time interval. Allows you to set a maximum time interval (in minutes) for the PV to react to the control output command. The value 0 (zero) disables the function.</p> <p>Available only for the Loop Break Detection Alarm (<b>Lbd</b>) function. See <a href="#">LOOP BREAK DETECTION (LBD) FUNCTION</a> section.</p>
<b>t1.A1</b> <b>t1.A2</b> <b>t1.A3</b> <b>t1.A4</b> <i>Time t1 Alarm</i>	<p>Allows you to define the time interval of <b>T1</b> to trigger the alarms. In seconds.</p> <p>The value 0 (zero) disables the function.</p>
<b>t2.A1</b> <b>t2.A2</b> <b>t2.A3</b> <b>t2.A4</b> <i>Time t2 Alarm</i>	<p>Allows you to define the time interval of <b>T2</b> to trigger the alarms. In seconds.</p> <p>The value 0 (zero) disables the function.</p>
<b>E.SP1</b> <b>E.SP2</b> <b>E.SP3</b> <b>E.SP4</b> <i>Enabled setpoint</i>	<p>Allows you to display the <b>SP.A1</b>, <b>SP.A2</b>, <b>SP.A3</b> or <b>SP.A4</b> parameters in the Operation Cycle. See <a href="#">OPERATION CYCLE</a> section.</p> <p>Available for the following alarm modes: <b>Lo</b>, <b>H i</b>, <b>d iF</b>, <b>d iF.L</b> and <b>d iF.H</b>.</p>
<b>FLS.1</b> <b>FLS.2</b> <b>FLS.3</b> <b>FLS.4</b> <i>Flash</i>	<p>Allows you to signal the occurrence of alarm conditions by flashing the PV indication on the display screen. See <a href="#">DISPLAY INFORMATION</a> section.</p> <p><b>YES</b> – Enables the function  <b>No</b> – Disables the function</p>

Table 8 – Alarm cycle



#### 4.3.4 INPUT CYCLE (CFG >> IN)

This is the Input Cycle:



Figure 27 – Input Cycle

<p><b>TYPE</b> Type</p>	<p>Input type. Allows you to select the input type to be used:</p> <ul style="list-style-type: none"> <li>J (tc d) Range: -110 to 950 °C (-166 to 1742 °F)</li> <li>K (tc K) Range: -150 to 1370 °C (-238 to 2498 °F)</li> <li>T (tc E) Range: -160 to 400 °C (-256 to 752 °F)</li> <li>N (tc N) Range: -270 to 1300 °C (-454 to 2372 °F)</li> <li>R (tc R) Range: -50 to 1760 °C (-58 to 3200 °F)</li> <li>S (tc S) Range: -50 to 1760 °C (-58 to 3200 °F)</li> <li>B (tc b) Range: 400 to 1800 °C (752 to 3272 °F)</li> <li>E (tc E) Range: -90 to 730 °C (-130 to 1346 °F)</li> <li>Pt100 (Pt) Range: -200 to 850 °C (-328 to 1562 °F)</li> </ul> <p>0-20 mA (L0.20) 4-20 mA (L4.20) 0-50 mV (L0.50) 0-5 Vcc (L0.5) 0-10 Vcc (L0.10)</p> <p>Analog Linear Signal Programmable indication from -1999 to 9999.</p> <p><b>You must configure this parameter first.</b></p>
<p><b>FLtr</b> Filter</p>	<p>Input filter. The filter is used to improve the stability of the measured signal (PV). Adjustable between 0 and 9999. At 0, it means that the filter is off. At 9999, it means that the filter is at maximum. The larger the filter, the slower the response of the measured value.</p>
<p><b>unit</b> unit</p>	<p>Allows you to set the temperature unit: Celsius °C or Fahrenheit °F.</p>
<p><b>dP.Po</b></p>	<p>Allows you to define the decimal point position in SP and PV values: 0 – No decimal places</p>

<b>decimal Point</b>	<b>0.0</b> – One decimal place When configuring the input parameter ( <b>TYPE</b> ) with temperature sensors (J, K, Pt10 etc.), in addition to the integer part of the measurement, only decimal values (XXX.X) will be displayed. For linear signals (mA, mV, V), this parameter determines the decimal point position of the measured value (XXXX, XXX.X, XX.XX, X.XXX).
<b>IN.LL</b> <i>Input Low Limit</i>	Indication range limits for the selected linear input.
<b>IN.HL</b> <i>Input High Limit</i>	Parameters available for <b>linear inputs</b> only (see table in <a href="#">ANALOGIC INPUT CONFIGURATION</a> section).
<b>OFFS</b> <i>Offset</i>	Allows you to adjust the indicated PV value. Default value: 0.
<b>SQRt</b> <i>Square Root</i>	Square Root Function. Applies the quadratic function on the input signal, within the limits programmed in parameters <b>SPLL</b> and <b>SPHL</b> . <b>YES</b> – Enables. <b>no</b> – Disables. The display assumes the lower limit value when the input signal is lower than 1% of its excursion. Parameter available for <b>linear inputs</b> (see table in <a href="#">ANALOGIC INPUT CONFIGURATION</a> section).

Table 9 – Input cycle

#### 4.3.5 OUTPUT A CYCLE (CFG >> out.A)

This is the Output A Cycle:



Figure 28 – Output A Cycle

<b>Fu.oA</b> <i>Function output A</i>	Allows you to define the output A function: <b>oFF</b> – No function <b>MV 1</b> – Output will act as control output 1 <b>MV 2</b> – Output will act as control output 2 <b>A 1</b> – Output will act as alarm output 1 <b>A 2</b> – Output will act as alarm output 2 <b>A 3</b> – Output will act as alarm output 3 <b>A 4</b> – Output will act as alarm output 4 <b>T 1</b> – Output will act as timer output 1 <b>T 2</b> – Output will act as timer output 2 <b>M.Coil</b> – Output will act as a Modbus-Coil command for connection to the Modbus-TCP protocol
--	---

Table 10 – Output A Cycle

### 4.3.6 OUTPUT B CYCLE (CFG >> ouEb)

This is the Output B Cycle:



Figure 29 – Output B cycle

<p><b>Fu.ob</b> <i>Function output B</i></p>	<p>Allows you to define the output B function:</p> <ul style="list-style-type: none"> <li><b>oFF</b> – No function</li> <li><b>MV 1</b> – Output will act as control output 1</li> <li><b>MV 2</b> – Output will act as control output 2</li> <li><b>A 1</b> – Output will act as alarm output 1</li> <li><b>A 2</b> – Output will act as alarm output 2</li> <li><b>A 3</b> – Output will act as alarm output 3</li> <li><b>A 4</b> – Output will act as alarm output 4</li> <li><b>T 1</b> – Output will act as timer output 1</li> <li><b>T 2</b> – Output will act as timer output 2</li> <li><b>M.Coil</b> – Output will act as a Modbus-Coil command for connection to the Modbus-TCP protocol</li> </ul>
--	---

Table 11 – Output B function

### 4.3.7 MODULES CYCLE (CFG >> Md. 1 or the module number according to its position in the dock)

This device holds up to 8 ClickNGo modules or up to the limit according to the size of the module you have used (see [CLICKNGO MODULES](#) section).

The device will only display the reference to the slot of the module added to the device. If a module has been added in slot 2, for example, the device will display the configuration section for this module (**Md. 2**). The other modules will remain inactive while not being used and will not appear in the display during manual configuration or in the software and application configuration screens.

You can see the configuration information for each module in their respective datasheets, available at **NOVUS** web page.

<b>Md. 1</b>	Module 1 function. Only displayed if a ClickNGo module is in this slot.
<b>Md. 2</b>	Module 2 function. Only displayed if a ClickNGo module is in this slot.
<b>Md. 3</b>	Module 3 function. Only displayed if a ClickNGo module is in this slot.
<b>Md. 4</b>	Module 4 function. Only displayed if a ClickNGo module is in this slot.
<b>Md. 5</b>	Module 5 function. Only displayed if a ClickNGo module is in this slot.
<b>Md. 6</b>	Module 6 function. Only displayed if a ClickNGo module is in this slot.
<b>Md. 7</b>	Module 7 function. Only displayed if a ClickNGo module is in this slot.
<b>Md. 8</b>	Module 8 function. Only displayed if a ClickNGo module is in this slot.

Table 12 – Module cycle

### 4.3.8 PROGRAM CYCLE (CFG >> PRG)

This is the Program Cycle:



Figure 30 – Program cycle

This cycle allows you to set the parameters for creating and editing programs. For more information about programs, such as limits, examples, and related functions, see [RAMPS AND SOAKS PROGRAMS](#) chapter.

<p><b>PR.tY</b> <i>Program type</i></p>	<p>Allows you to define the program type:  <b>NONE</b> – Does not use any program  <b>R.tE</b> – Ramp and soak  <b>PRG</b> – Ramp and soak programs</p>
<p><b>r.tE</b> <i>Rate</i></p>	<p>Allows you to set the Setpoint evolution rate (in degrees per minute).          Available only for Ramp and Soak mode (<b>R.tE</b>).</p>
<p><b>t SP</b> <i>Time Setpoint</i></p>	<p>Allows you to set the time for a soak following the initial ramp.          Available only for Ramp and Soak mode (<b>R.tE</b>).</p>
<p><b>Pr.tb</b> <i>Program time base</i></p>	<p>Program time base. Allows you to set the program time base:  <b>MM:SS</b> – Time base in minutes:seconds  <b>HH:MM</b> – Time base in hours:minutes</p>

<p><b>Pr R</b> <i>Program Resume</i></p>	<p>Program resume function. Allows you to define the behavior of the controller when returning from a power failure in the middle of a ramps and soaks program:</p> <p><b>PrOG</b> – Returns at the beginning of the program  <b>P.SEG</b> – Returns at the beginning of the segment  <b>E.SEG</b> – Returns exactly where it has stopped  <b>oFF</b> – Returns with control disabled (<b>RUN = No</b>).</p>
<p><b>Pr N</b> <i>Program Number</i></p>	<p>Program being edited. Allows you to select the Ramps and Soaks program to be configured on the following screens of this cycle. You can create up to 20 programs.</p>
<p><b>PtOL</b> <i>Program tolerance</i></p>	<p>Allows you to set the maximum allowed deviation between PV and SP. If exceeded, the program is suspended (stops timing) until the deviation is within this tolerance.  The value 0 (zero) disables the function and the program progresses regardless of the difference between SP and PV.</p>
<p><b>PSP0</b> <b>PSP9</b> <i>Program SP</i></p>	<p>Program SPs (0 to 9). Set of 10 SP values that define the profile of the Ramps and Soaks program.</p>
<p><b>Pt1</b> <b>Pt9</b> <i>Program time</i></p>	<p>Time of the program segments (1 to 9). Allows you to define the duration (in seconds or minutes, as set in parameter <b>Pr.tb</b>) of each of the 9 program segments being edited.</p>
<p><b>PE1</b> <b>PE9</b> <i>Program Event</i></p>	<p>Event alarms (1 to 9). Allows you to define the alarms that will be triggered during a certain program segment.  The adopted alarms must be configured with the Event Alarm (<b>r5</b>) function (see <a href="#">ALARM CONFIGURATION</a> section).</p>
<p><b>LP</b> <i>Link Program</i></p>	<p>Program link. Allows you to connect one program to another. If set, another program can start after the first program has run.</p> <p><b>NONE</b> – Does not connect the current program to any other program  <b>1 to 20</b> – Connects the current program with the selected program number</p>

Table 13 – Program cycle

### 4.3.9 TIMER CYCLE (CFG >> EM)

This is the Timer Cycle:

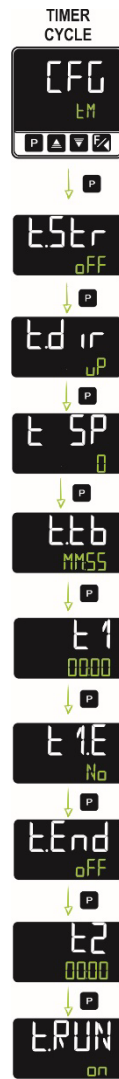

Figure 31 – Timer cycle

<p><b>E.St'r</b> <i>Timer Start</i></p>	<p>Starts the timer. Allows you to set the timer start mode:</p> <ul style="list-style-type: none"> <li><b>oFF</b> – Disabled</li> <li><b>SP</b> – Starts counting when the PV value reach the SP value</li> <li><b>F</b> – Starts counting when you press the <b>F</b> key</li> <li><b>RUN</b> – Starts counting when control is enabled (<b>RUN = YES</b>)</li> <li><b>d I</b> – Triggers with digital input</li> </ul>
<p><b>E.d ir</b> <i>Timer Direction</i></p>	<p>Counting mode. Allows you to set the timer counting mode:</p> <ul style="list-style-type: none"> <li><b>dn</b> – Backward mode</li> <li><b>uP</b> – Forward mode, starting from zero</li> </ul>
<p><b>E.t'b</b> <i>Timer time base</i></p>	<p>Timer time base. Allows you to set the timer time base:</p> <ul style="list-style-type: none"> <li><b>MM:SS</b> – Time base in minutes:seconds</li> <li><b>HH:MM</b> – Time base in hours:minutes</li> </ul>
<p><b>E 1</b> <i>Timer 1</i></p>	<p><b>E 1</b> time base. Allows you to set a time base for timer 1. Range: 00:00 to 99:59 (HH:MM or MM:SS, as set in parameter <b>E.t'b</b>).</p>
<p><b>E 1.E</b> <i>Timer 1 Enabled</i></p>	<p>If set to <b>YES</b>, allows the Timer 1 parameter (<b>E 1</b>) to be displayed (and set) in the Operation Cycle. See <a href="#">OPERATION CYCLE</a> section.</p>
<p><b>E.End</b> <i>Timer End</i></p>	<p>Allows you to set the behavior of the output <b>T1</b> when <b>T1</b> timer is expired.</p> <ul style="list-style-type: none"> <li><b>oFF</b> – Turns off the output at the end of the timer</li> <li><b>on</b> – Turns on the output at the end of the timer</li> </ul>
<p><b>E 2</b> <i>Timer 2</i></p>	<p><b>E 2</b> time base. Allows you to set a time interval at which <b>T2</b> output will remain on after T1 has expired. Range: 00:00 to 99:59 (HH:MM or MM:SS, as set in parameter <b>E.t'b</b>).</p>

**E.RUN**  
Timer Run

Allows you to define the behavior of the temperature control at the end of the T1 + T2 timers.

**on** – The temperature control continues to operate

**off** – Temperature control will be disabled at the end of the timer (**RUN = No**).

Table 14 – Timer cycle

**4.3.10 CALIBRATION CYCLE (CFG >> CAL ib)**

This is the Calibration Cycle:



Figure 32 – Calibration cycle

The inputs and outputs are factory calibrated. If necessary, recalibration must be performed by a specialized professional. If you access this cycle by accident, just go through all the parameters, avoiding changing their values.

<b>PASS</b> <i>Password</i>	Allows you to enter the password. This parameter is displayed before the protected cycles. See <a href="#">CONFIGURATION PROTECTION</a> section.
<b>CAI ib</b> <i>Calibration</i>	Allows you to calibrate the analog input.
<b>in.LE</b> <i>input Low Calibration</i>	Value corresponding to the low scale signal applied to the analog input. See <a href="#">INPUT CALIBRATION</a> section. This parameter will be displayed if you set the <b>CAI ib</b> parameter to <b>YES</b> .
<b>in.HE</b> <i>input High Calibration</i>	Value corresponding to the full-scale signal applied to the analog input. See <a href="#">INPUT CALIBRATION</a> section. This parameter will be displayed if you set the <b>CAI ib</b> parameter to <b>YES</b> .
<b>R.CAL</b> <i>Restore Calibration</i>	Allows you to restore factory calibrations, erasing all changes made.
<b>R.CFG</b> <i>Restore Configuration</i>	Allows you to restore factory settings, erasing all changes made.
<b>PAS.C</b> <i>Password Change</i>	Allows you to set a new password, always different from 0 (zero).
<b>Prot</b> <i>Protection</i>	Allows you to configure the Protection Level. See <a href="#">CONFIGURATION PROTECTION</a> section.
<b>FREQ</b> <i>Frequency</i>	Allows you to set the mains frequency: 50 Hz or 60 Hz.
<b>CEr.E</b> <i>Control Enabled</i>	If set to <b>YES</b> , allows the Control parameter ( <b>CEr</b> ) to be displayed (and set) in the Operation Cycle. See <a href="#">OPERATION CYCLE</a> section.
<b>PRG.E</b> <i>Program Enabled</i>	If set to <b>YES</b> , allows the Programs parameter ( <b>PRG</b> ) to be displayed (and set) in the Operation Cycle. See <a href="#">OPERATION CYCLE</a> section.
<b>RUN.E</b> <i>Run Enabled</i>	If set to <b>YES</b> , allows the <b>RUN</b> parameter to be displayed (and set) in the Operation Cycle. See <a href="#">OPERATION CYCLE</a> section.
<b>bLE.E</b> <i>Bluetooth Enabled</i>	If set to <b>YES</b> , allows the Bluetooth interface of the device to connect to the Bluetooth interface of the smartphone being used (see <a href="#">BLUETOOTH INTERFACE</a> section). Once the connection between the device and the smartphone has been successfully made, the controller will show a Bluetooth flag on its display (see <a href="#">DISPLAY INFORMATION</a> section). You must use the <b>QuickTune Mobile</b> application to configure the controller through the Bluetooth connection with a smartphone (see <a href="#">CONFIGURATION SOFTWARE</a> chapter).
<b>SnH</b> <i>Serial Number High</i>	Displays the first four numbers of the device serial number.
<b>SnL</b> <i>Serial Number Low</i>	Displays the last four numbers of the device serial number.

Table 15 – Calibration cycle



## 4.4 CONFIGURATION PROTECTION

You can protect the configuration of a parameter cycle and prevent undue changes by setting a protection for the device. To do this, access the parameter **Protection (PRDL)**, present in the cycle Configuration (**CFG**) >> Calibration (**CR1** - **ib**), and determine the level of protection to be adopted, limiting access to certain cycles, as shown in the table below:

PROTECTION LEVELS	PROTECTED CYCLES
1	Only the Calibration cycle is protected.
2	All Configuration cycles are blocked. The Operation cycle is unblocked.
3	All cycles are blocked, except for the SP configuration.
4	All cycles and parameters are blocked.

Table 16 – Configuration Protection Levels

Once you have set a protection password for a cycle, you will always need to enter it (or until you remove the protection).

### 4.4.1 PASSWORD

When accessing a protected cycle, you will need to enter the password in the **Password (PR55)** parameter, which is shown in the first of the protected cycles. If entered correctly, this password allows you to change the parameter settings of this cycle.

If you have not entered any password, you can only view the parameters of the protected cycles.

You can set a password in the Password Change parameter (**PR5.C**), present in cycle Configuration (**CFG**) >> Calibration (**CR1** - **ib**). To do so, simply fill in this parameter with the desired password.

The controllers leave the factory with the password set as 1111.

### 4.4.2 PASSWORD PROTECTION

The controller has a security system that prevents you from entering multiple passwords to get the right one. Once the controller has identified the entry of 5 invalid passwords in sequence, it will not allow you to make further attempts for 10 minutes.

### 4.4.3 MASTER PASSWORD

If you have forgotten your password, you can use the Master Password feature. It is composed by the last three digits of the controller serial number **plus** the number 9000.

The master password for a device with serial number 07154321, for example, will be 9 3 2 1.

## 4.5 COMMUNICATION INTERFACES

### 4.5.1 USB INTERFACE

**N20K48 Modular Controller** has a USB interface on the bottom of its housing. You must use the USB interface to configure, monitor, and analyze the device through the **QuickTune** software (see [CONFIGURATION SOFTWARE](#) chapter). You must use a standard micro-USB cable (not supplied) to connect the device to a PC.

The USB port drivers will be automatically installed during **QuickTune** installation.

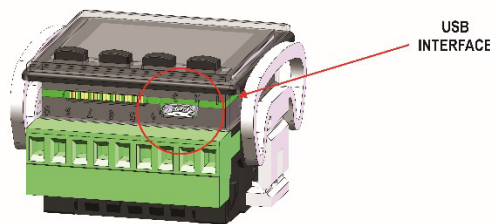

Figure 33 – USB cable connection



The USB interface is **NOT** electrically isolated from the input and OUTA circuits.  
Its purpose is for temporary use during **CONFIGURATION AND DIAGNOSIS** of the device.

### 4.5.2 BLUETOOTH INTERFACE

**N20K48 Modular Controller** has a Bluetooth Low Energy (BLE) interface, compatible with smartphones that have Bluetooth modules with version 4.1 or higher.

The Bluetooth interface allows you to configure the device through the **QuickTune Mobile** application (see [QUICKTUNE MOBILE](#) section).

If you enable the device Bluetooth interface (**CFG** >> **CR1** - **ib** >> **BLE.E** → **YES**) and successfully connect the **N20K48 Modular Controller** to the smartphone, the device display will display the Bluetooth flag.

It is not necessary to add the device to the smartphone. The connection is made automatically by the **QuickTune Mobile**.

## 5 RAMPS AND SOAKS PROGRAMS

**N20K48 Modular Controller** allows you to create a behavior profile for the process, called RAMP AND SOAK PROGRAM. You can set up to **20 different profiles** with **9 segments** each. You can also create longer profiles of up to 180 segments by linking 2 or more profiles.

The figure below shows an example:

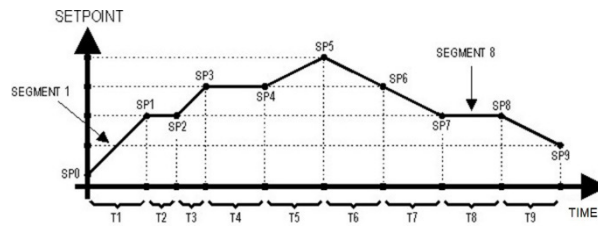

Figure 34 – Ramp and soak program example

After you define and execute the program, the device starts to generate the SP according to the created program.

To execute a program with a smaller number of segments, you must program 0 (zero) for the time values of the segments that follow the last segment to be executed.

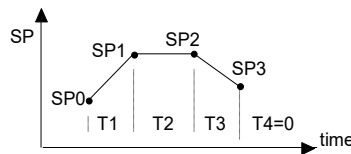

Figure 35 – Example of a program with few segments

The Program Tolerance function (**PEoL**), present in the Configuration (**CFG**) >> Programs (**PROG**) cycle, defines the maximum deviation between PV and SP during program execution. If this deviation is exceeded, the time count will be interrupted until the deviation is within the programmed tolerance (gives priority to SP). If the tolerance is set to 0 (zero), the controller will execute the defined program without considering any deviations between PV and SP (gives priority to time).

The configured **time limit** for each segment is 9999 and can be displayed in seconds or minutes, depending on the time base configured.

### 5.1 PROGRAM LINK

You can create a large, more complex program, with up to **180 segments**, by linking **20 programs**. Thus, at the end of a program, the controller will immediately start executing another one, as configured in the **Link Programs (LP)** parameter, present in Configuration (**CFG**) >> Programs (**PROG**) cycle.

You can connect a program to itself or the last program to the first program so that the device runs a program (or programs) continuously.

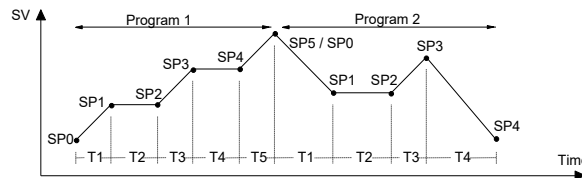

Figure 36 – Example of linked programs

### 5.2 EVENT ALARM

The Event Alarm function allows you to configure an alarm to be trigger in specific segments of a program.

To configure an event alarm, you must access the Alarm cycle (**CFG** >> **ALM**), select the desired alarm (**Fu.A1**, **Fu.A2**, **Fu.A3** or **Fu.A3**) and configure it in Event Alarm (**r5**) mode. Then you must access the Program cycle (**CFG** >> **PROG**) and configure parameters **PE 1** to **PE4** with the desired alarm numbers (1, 2, 3, 4).

If the Program Tolerance (**PEoL**) parameter, located within the Program Cycle (**CFG** >> **PROG**), is other than 0 (zero), the controller will wait for the PV to reach the first program setpoint **SP0** before running the program. Otherwise, it will be started immediately.

Upon returning from a power outage, the controller resumes program execution from the beginning of the segment in which it was interrupted.

For more information about the alarm types, see [ALARM CONFIGURATION](#) section.

For more information about the parameters of each cycle, see [PARAMETER DESCRIPTION](#) section.

## 6 PID PARAMETERS

The adjustment of the PID control parameters can be done in automatic mode and auto-adaptive mode. **Auto-tuning** is initiated at the operator request. **Auto-adaptive tuning** is initiated by the controller whenever the control performance is lower than desired.

### 6.1 AUTO-TUNING

At the start of the auto-tuning process, the controller has the behavior of an ON/OFF controller. It applies minimum and maximum performance to the process. Throughout the tuning process, the controller performance is refined until it is completed, already under optimized PID control. It is started after you select one of the options **FAST**, **FULL**, **SELF**, **RSLF** or **EGHE**, set in the **AEUN** parameter (**Ctrl** >> **AEun**).

The process can be seen below:

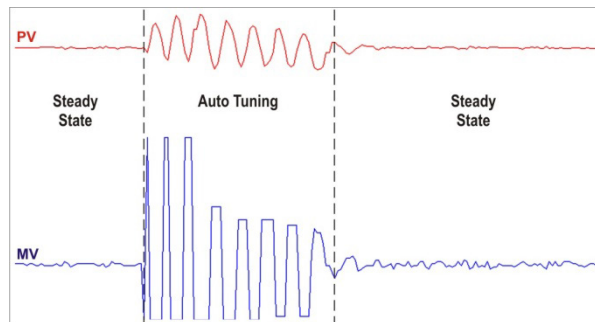

Figure 37 – Example of auto-tuning

### 6.2 AUTO-ADAPTATIVE TUNING

The auto-adaptive tuning is started by the controller whenever its performance is worse than what was found after the previous tuning. To activate performance supervision and auto-adaptive tuning, you must set the **AEUN** parameter (**Ctrl** >> **AEun**) in **SELF**, **RSLF** or **EGHE** mode.

During auto-adaptive tuning, the behavior of the controller depends on its performance. If the mismatch is small, you will hardly notice the tuning. If the mismatch is large, the auto-adaptive tuning is like the auto-tuning mode, applying the minimum and maximum performance to the process in ON/OFF control.

The process can be seen below:

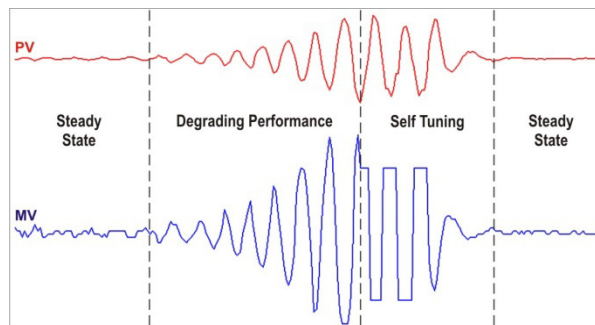

Figure 38 – Example of auto-adaptive tuning

You can select the tuning type in the **AEUN** parameter:

- **OFF**: The controller does not perform auto-tuning or auto-adaptive tuning. The PID parameters will not be automatically determined or optimized by the controller.
- **FAST**: The controller will perform the auto-tuning process only once, returning to **OFF** mode after it is finished. In this mode, the tuning will be completed in less time, but will not be as precise as in **FULL** mode.
- **FULL**: This mode performs the same process as **FAST** mode, although the tuning is more precise and slower, resulting in better PID control performance.
- **SELF**: The process performance is monitored, and auto-adaptive tuning will start whenever the performance becomes unsatisfactory. After an adjustment cycle, the controller will start collecting data about the process. This helps it to create a reference, which is used to assess the need for further adjustments.

This phase is proportional to the response time of the process.

- **RSLF**: The controller performs the auto-tuning process and returns to **SELF** mode. Normally, this mode is used to force immediate auto-tuning of a controller that is operating in **SELF** mode.
- **EGHE**: Like **SELF** mode. In addition to auto-adaptive tuning, performs auto-tuning whenever the controller is set to **RUN = YES** or when the controller is powered up.

Whenever you change the **AEUN** parameter to a value other than **OFF**, auto-tuning will be immediately started by the controller (if the controller is not set to **RUN = YES**, tuning will start when it transitions to this condition). For the auto-adaptive tuning to work properly, it is essential to perform auto-tuning.

The auto-tuning and auto-adaptive tuning methods are suitable for most industrial processes. However, there may be processes or even situations where the methods will not be able to determine the controller parameters properly. This results in undesired oscillations or leads the process to extreme conditions.

The oscillations imposed by the tuning methods may be intolerable for certain processes. You must consider these effects before using the controller and take preventive measures to ensure the integrity of the process and users.

It is recommended that you do not turn off the controller or change the SP during this process.

During the tuning process, the TUNE indicator will remain lit in the display (see [DISPLAY INFORMATION](#) section).

For PWM or pulse output, the quality of the tuning will also depend on the cycle time set.

If the tuning process does not result in satisfactory control, the table below presents guidelines on how to correct the process behavior:

PARAMETER	VERIFIED PROBLEM	SOLUTION
<b>Proportional Band</b>	Slow response	Decrease
	Great oscillation	Increase
<b>Integral Rate</b>	Slow response	Increase
	Great oscillation	Decrease
<b>Derivative Time</b>	Slow response or instability	Decrease
	Great oscillation	Increase

**Table 17 – Manual PID parameter setting**

## 7.1 QUICKTUNE

**QuickTune** software was developed especially for **NOVUS** controllers and indicators. With a user-friendly and practical interface, it facilitates device configuration and management, and communicates through USB, Bluetooth, and RS485 interfaces (in this case, with the ClickNGo **CG-485** module) or through a TCP/IP connection.

This manual describes the functionalities related to the device configuration. For more information, check the specific operations manual. The software can be downloaded free of charge from our website [www.novusautomation.com](http://www.novusautomation.com), in the Download Area.

## 7.2 QUICKTUNE MOBILE

**QuickTune Mobile** is the ideal tool to daily access your **N20K48 Modular Controller**. Available for Android and iOS smartphones, it allows you to configure or monitor your device. Connection to the device can be made via the Bluetooth interface.

**QuickTune Mobile** can be downloaded for free from the Google Play Store or the Apple Store. Once the application has been installed, you must enable the Bluetooth interface of the smartphone to connect it to the device. For more information about how to enable the Bluetooth interface of the **N20K48 Modular Controller**, see [BLUETOOTH INTERFACE](#) section of this manual.

If your smartphone does not support BLE technology, has an Android version less than 9.0, or an iOS version less than 12, the application will not be available for download.

**QuickTune Mobile** uses the native iOS "Files" app for file management.

## 7.3 CONFIGURING THE DEVICE WITH QUICKTUNE

You can configure your **N20K48 Modular Controller** by clicking the **Read Device** button, located on the **QuickTune** software home screen (Windows) and the **QuickTune Mobile** app home screen (Android or iOS).

The following sections describe each of the configurable parameters.

### 7.3.1 BASIC

This screen allows you to configure the main parameters of the controller:

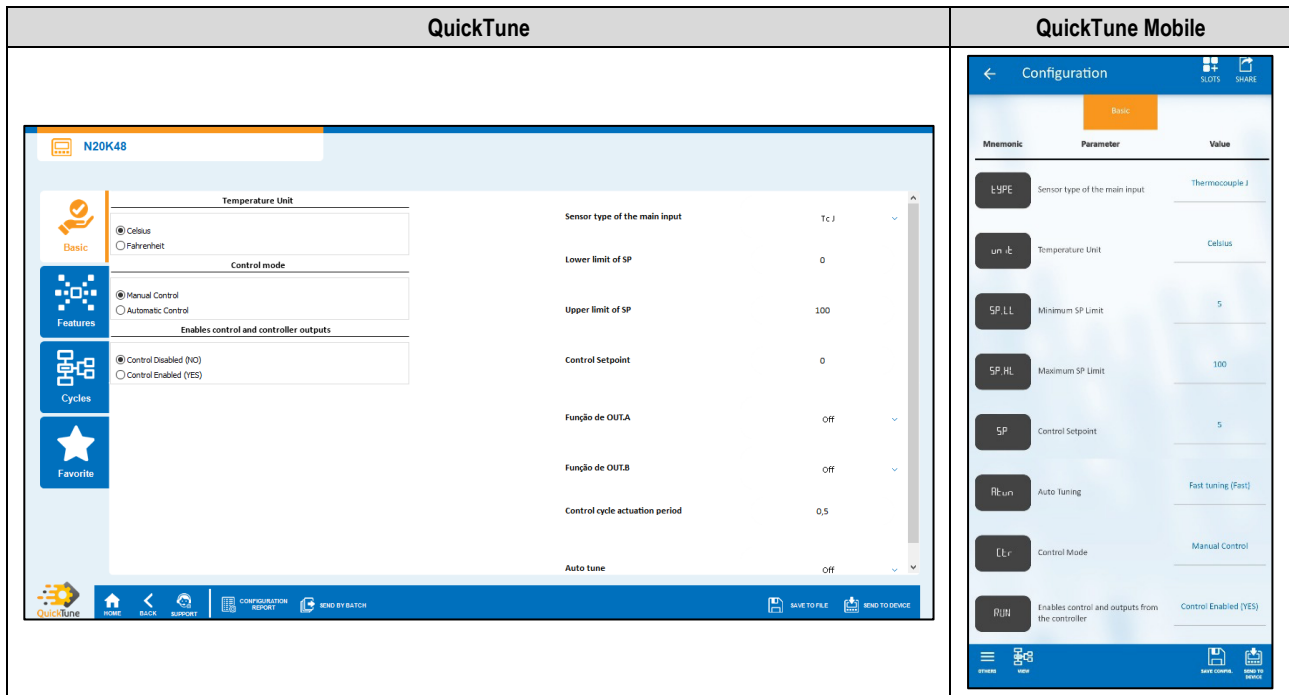

Figure 39 – Basic tab

- **Temperature Unit:** Allows you to define the temperature unit to be used: "Celsius" or "Fahrenheit".
- **Control Mode:** Allows you to define the control mode of the device: "Manual" or "Automatic" (see [CONTROL MODES](#) section).
- **Enables control and controller outputs:** Allows you to enable control and outputs.
- **Sensor type of the main input:** Allows you to define the sensor type of the main input (see [ANALOG INPUT CONFIGURATION](#) section).
- **Lower limit of SP:** Allows you to define the lower limit for the Setpoint adjustment. Allows you to define the minimum value of the PV indication range and limit the SP adjustment of the available **linear analog signal inputs** (0-20 mA, 4-20 mA, 0-50 mV, 0-5 V and 0-10 V).
- **Upper limit of SP:** Allows you to define the upper limit for the Setpoint adjustment. Allows you to define the maximum value of the PV indication range and limit the SP adjustment of the available **linear analog signal inputs** (0-20 mA, 4-20 mA, 0-50 mV, 0-5 V and 0-10 V).
- **Control Setpoint:** Allows you to define the control setpoint, according to the minimum and maximum limits of the configured SP.
- **OUT.A Function:** Allows you to define **OUT.A** output function: "Off", "Control Output 1", "Control Output 2", "Alarm 1", "Alarm 2", "Alarm 3", "Alarm 4", "Timer 1", "Timer 2" or "Modbus-Coil" (see [OUTPUT CONFIGURATION](#) section).

- **OUT.B Function:** Allows you to define **OUT.B** output function: “Off”, “Control Output 1”, “Control Output 2”, “Alarm 1”, “Alarm 2”, “Alarm 3”, “Alarm 4”, “Timer 1”, “Timer 2” or “Modbus-Coil” (see [OUTPUT CONFIGURATION](#) section).
- **Control cycle action period:** Allows you to define the PWM cycle value. Available only when the **Proportional Band** parameter is  $\neq 0$ . Range: 0,5 ~ 100,0 (in seconds).
- **Auto-Tuning:** Allows you to define the auto-tuning mode: “Off”, “Fast tuning”, “Precise tuning”, “Precise and auto-adaptative tuning”, “New precise and auto-adaptative tuning”, “New precise and auto-adaptative tuning when **RUN = YES**” (see [PID PARAMETERS](#) chapter).

### 7.3.2 FEATURES

This screen is divided into tabs, which group the features by parameter type. Information regarding ClickNGo modules can be viewed in the specific module datasheet.

#### 7.3.2.1 ANALOG INPUT

This tab allows you to configure the parameters related to the analog input:

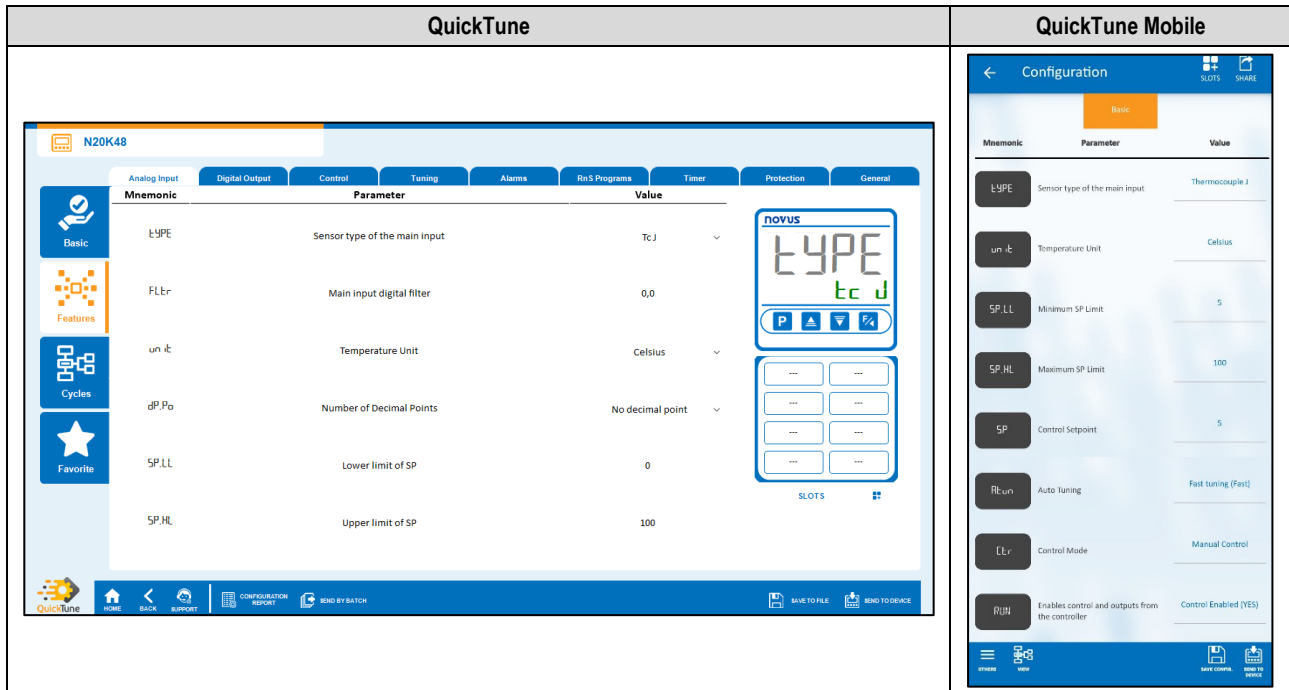

Figure 40 – Analog input tab

- **Sensor type of the main input:** Allows you to define the sensor type of the main input (see [ANALOG INPUT CONFIGURATION](#) section).
- **Temperature Unit:** Allows you to define the temperature unit to be used: “Celsius” or “Fahrenheit”.
- **Decimal Places:** Allows you to define the number of decimal places to be used when displaying SP and PV values: “No decimal places” or “One decimal place”.
- **Main input digital filter:** Allows you to define a filter for the main input. Used to improve the stability of the measured signal (PV). Adjustable between 0 and 999.9. At 0, it means that the filter is off. At 999.9, it means the filter is at maximum. The larger the filter, the slower the response of the measured value.
- **Lower limit of SP:** Allows you to define the lower limit for the Setpoint adjustment. Allows you to define the minimum value of the PV indication range and limit the SP adjustment of the available **linear analog signal inputs** (0-20 mA, 4-20 mA, 0-50 mV, 0-5 V and 0-10 V).
- **Upper limit of SP:** Allows you to define the upper limit for the Setpoint adjustment. Allows you to define the maximum value of the PV indication range and limit the SP adjustment of the available **linear analog signal inputs** (0-20 mA, 4-20 mA, 0-50 mV, 0-5 V and 0-10 V).

### 7.3.2.2 DIGITAL OUTPUT

This tab allows you to configure the parameters related to the digital outputs:

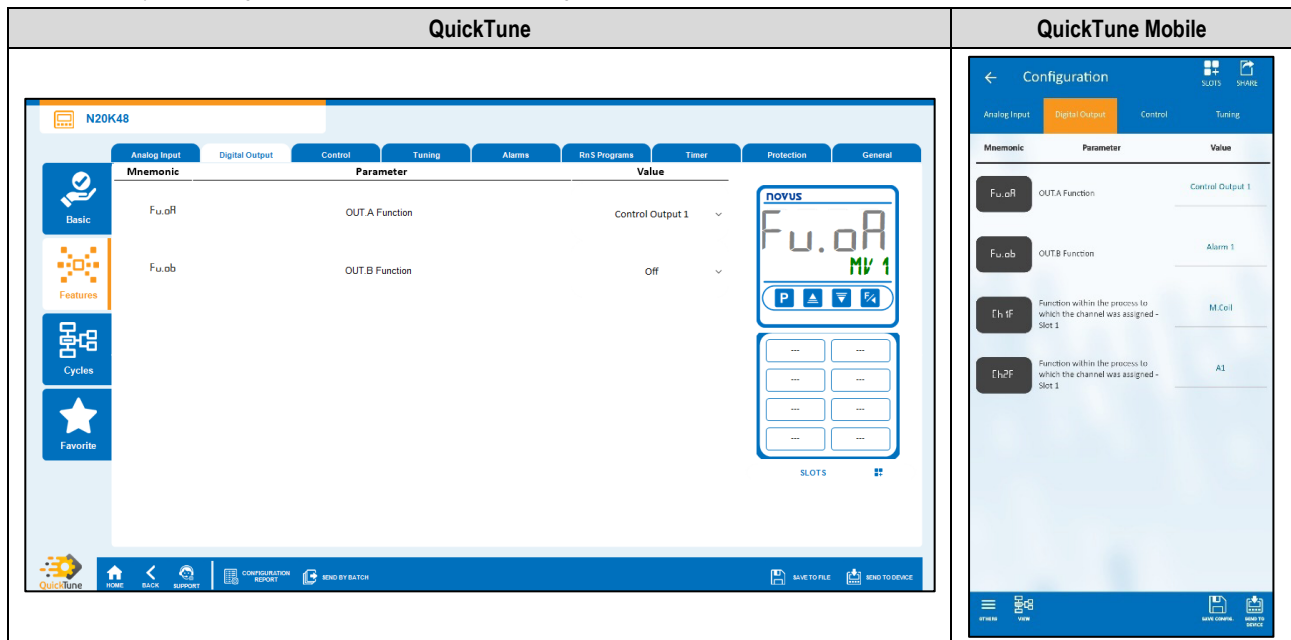

Figure 41 – Digital Output tab

- **OUT.A Function:** Allows you to define **o.u.t.a** output function: “Off”, “Control Output 1”, “Control Output 2”, “Alarm 1”, “Alarm 2”, “Alarm 3”, “Alarm 4”, “Timer 1”, “Timer 2” or “Modbus-Coil” (see [OUTPUT CONFIGURATION](#) section).
- **OUT.B Function:** Allows you to define **o.u.t.b** output function: “Off”, “Control Output 1”, “Control Output 2”, “Alarm 1”, “Alarm 2”, “Alarm 3”, “Alarm 4”, “Timer 1”, “Timer 2” or “Modbus-Coil” (see [OUTPUT CONFIGURATION](#) section).

### 7.3.2.3 CONTROL

This tab allows you to configure the parameters related to the control mode:

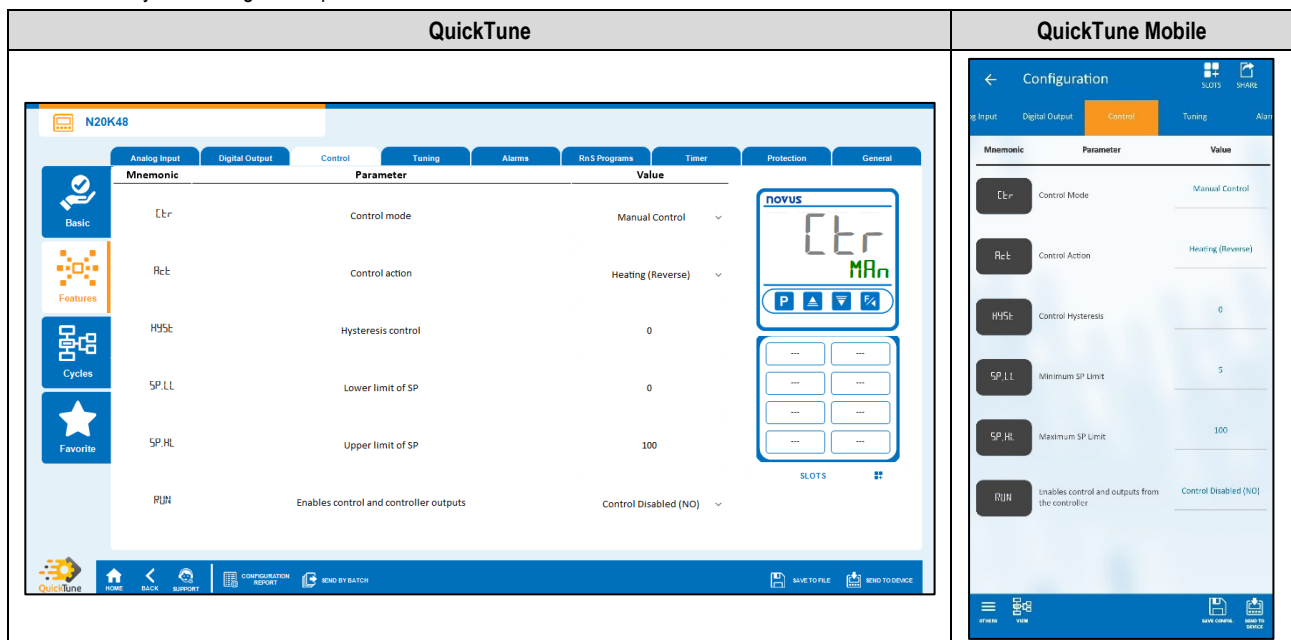

Figure 42 – Control tab

- **Control Mode:** Allows you to define the control mode: “Manual” or “Automatic” (see [CONTROL MODES](#) section).
- **Control Action:** Allows you to enable the control logic to be used: “Heating (Reverse)”, which turns on the control output when the PV is below SP, or “Cooling (Direct)”, which turns on the control output when the PV is above SP. Available only for “Automatic” control mode.
- **Control Hysteresis:** Allows you to define a hysteresis value for ON/OFF control mode (To define an ON/OFF control mode, the **Proportional Band** parameter of the Tuning tab must be set to 0.0). Adjustable between 0 and the measurement range width of the selected input type.
- **Lower limit of SP:** Allows you to define the lower limit for the Setpoint adjustment. Allows you to define the minimum value of the PV indication range and limit the SP adjustment of the available **linear analog signal inputs** (0-20 mA, 4-20 mA, 0-50 mV, 0-5 V and 0-10 V).
- **Upper limit of SP:** Allows you to define the upper limit for the Setpoint adjustment. Allows you to define the maximum value of the PV indication range and limit the SP adjustment of the available **linear analog signal inputs** (0-20 mA, 4-20 mA, 0-50 mV, 0-5 V and 0-10 V).
- **Enables control and controller outputs:** Allows you to enable control and outputs.

### 7.3.2.4 TUNING

This tab allows you to configure the parameters related to the tuning mode:

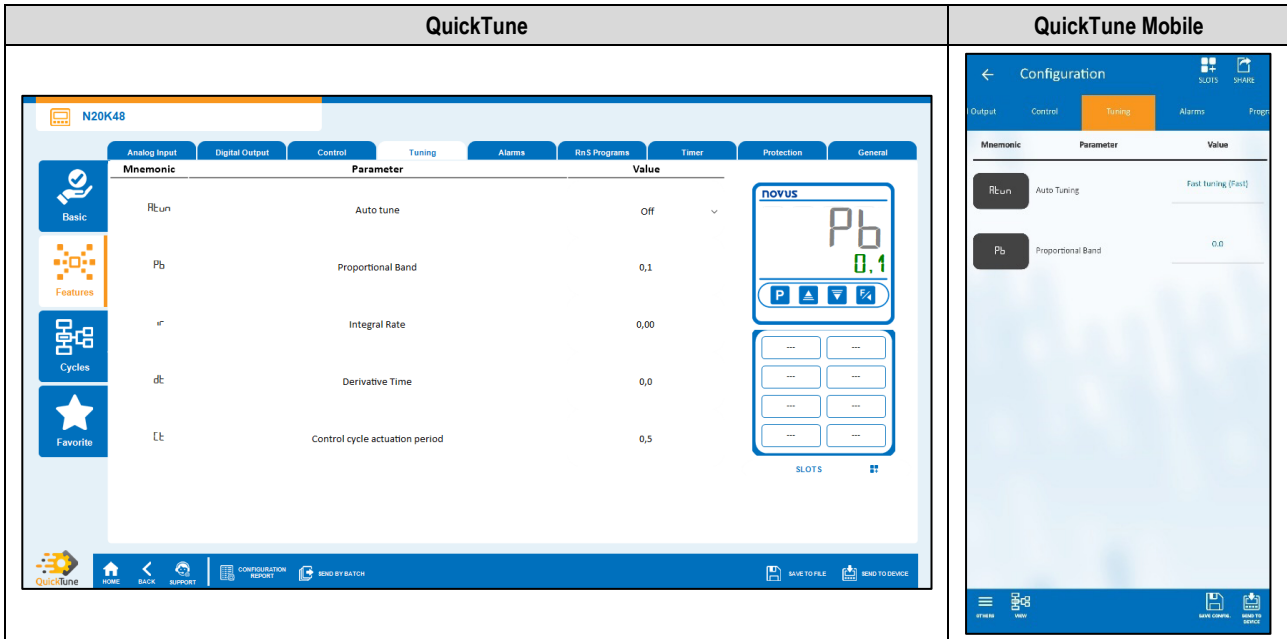

Figure 43 – Tuning tab

- **Auto-Tuning:** Allows you to define the auto-tuning mode: “Off”, “Fast tuning”, “Precise tuning”, “Precise and auto-adaptative tuning”, “New precise and auto-adaptative tuning”, “New precise and auto-adaptative tuning when **RUN = YES**” (see [PID PARAMETERS](#) chapter).
- **Proportional Band:** Allows you to define the proportional band. It refers to the **P** value of the PID control mode, as a percentage of the input type maximum range. **When set to 0.0, determines the ON/OFF control mode.** Range: 0 ~ 500.
- **Integral Rate:** Allows you to define the integral rate. It refers to the **I** value of the PID control mode, in repetitions per minute (Reset). Available only when the **Proportional Band** parameter is  $\neq 0$ . Range: 0 ~ 99.99 (in seconds).
- **Derivative Time:** Allows you to define the derivative time. It refers to the **D** value of the PID control mode, in seconds. Available only when the **Proportional Band** parameter is  $\neq 0$ . Range: 0 ~ 300,0 (in seconds).
- **Control cycle action period:** Allows you to define the PWM cycle value. Available only when the **Proportional Band** parameter is  $\neq 0$ . Range: 0,5 ~ 100,0 (in seconds).



### 7.3.2.5 ALARMS

This tab allows you to configure the parameters related to the alarm functions:

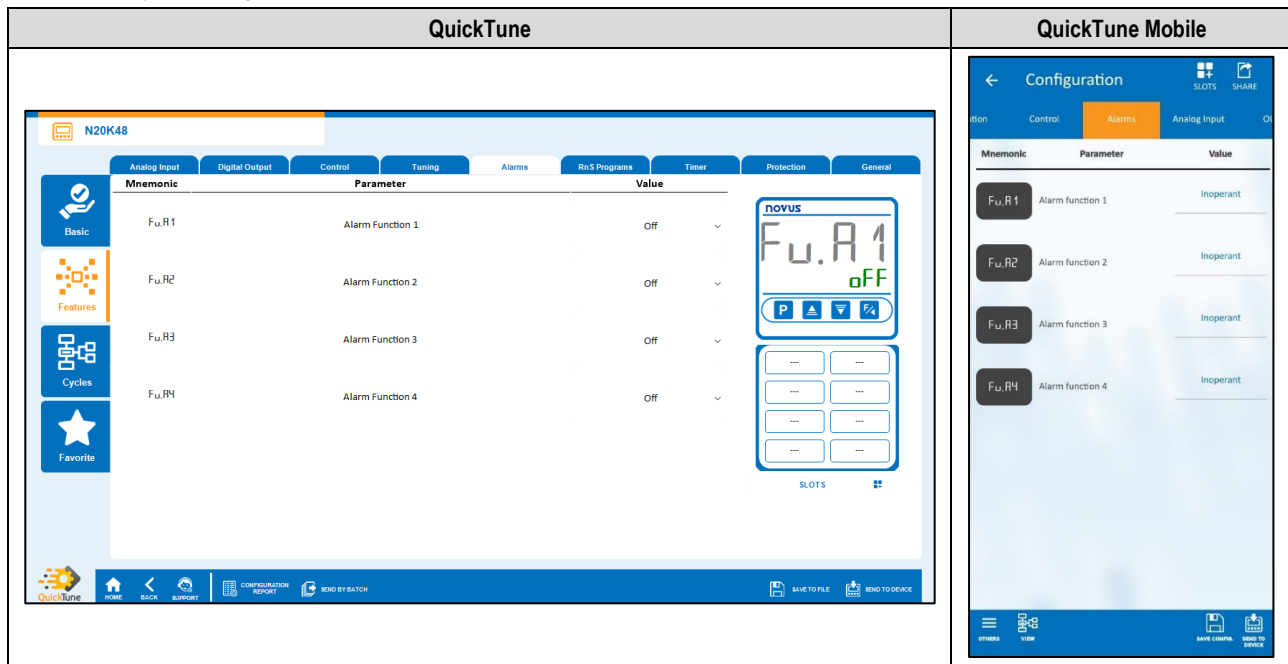

Figure 44 – Alarms tab

- **Alarm 1 Function:** Allows you to define alarm 1 function: “Off”, “Minimum”, “Maximum”, “Differential”, “Minimum Differential”, “Maximum Differential”, “Open Sensor”, “Ramps and Soaks Event”, “End of Soak” or “Open Loop” (see [ALARM CONFIGURATION](#) section).
- **Alarm 2 Function:** Allows you to define alarm 2 function: “Off”, “Minimum”, “Maximum”, “Differential”, “Minimum Differential”, “Maximum Differential”, “Open Sensor”, “Ramps and Soaks Event”, “End of Soak” or “Open Loop” (see [ALARM CONFIGURATION](#) section).
- **Alarm 3 Function:** Allows you to define alarm 3 function: “Off”, “Minimum”, “Maximum”, “Differential”, “Minimum Differential”, “Maximum Differential”, “Open Sensor”, “Ramps and Soaks Event”, “End of Soak” or “Open Loop” (see [ALARM CONFIGURATION](#) section).
- **Alarm 4 Function:** Allows you to define alarm 4 function: “Off”, “Minimum”, “Maximum”, “Differential”, “Minimum Differential”, “Maximum Differential”, “Open Sensor”, “Ramps and Soaks Event”, “End of Soak” or “Open Loop” (see [ALARM CONFIGURATION](#) section).

#### PARAMETERS OF EACH ALARM:

Each type of alarm has specific parameters. The sections below present the configuration parameters for Alarm 1 function modes, but all alarms have the same parameters.

#### MINIMUM ALARM

- **Alarm 1 SP:** Allows you to define the trigger point for Alarm 1. Range: According to the minimum and maximum SP limits configured.
- **Alarm 1 Initial Blocking:** Allows you to define whether there will be an initial block of alarm 1 (see [ALARM INITIAL BLOCK FUNCTION](#) section).
- **Alarm 1 Hysteresis:** Allows you to define a hysteresis value for Alarm 1.
- **T1 of Alarm 1:** Allows you to define a timer interval for the activation of Alarm 1. Range: 0 ~ 5999 (in seconds).
- **T2 of Alarm 1:** Allows you to define a second timer interval for the activation of Alarm 1. Range: 0 ~ 5999 (in seconds).
- **Displays SPA1 in the Operation Cycle:** Allows you to define whether the SPA1 of Alarm 1 will be displayed in the Operation Cycle of the device.
- **Flash in Alarm 1:** Allows you to define whether Alarm 1 will display an alert flag on the display when it is in an alarm situation (see [DISPLAY INFORMATION](#) section).

#### MAXIMUM ALARM

- **Alarm 1 SP:** Allows you to define the trigger point for Alarm 1. Range: According to the minimum and maximum SP limits configured.
- **Alarm 1 Initial Blocking:** Allows you to define whether there will be an initial block of alarm 1 (see [ALARM INITIAL BLOCK FUNCTION](#) section).
- **Alarm 1 Hysteresis:** Allows you to define a hysteresis value for Alarm 1.
- **T1 of Alarm 1:** Allows you to define a timer interval for the activation of Alarm 1. Range: 0 ~ 5999 (in seconds).
- **T2 of Alarm 1:** Allows you to define a second timer interval for the activation of Alarm 1. Range: 0 ~ 5999 (in seconds).
- **Displays SPA1 in the Operation Cycle:** Allows you to define whether the SPA1 of Alarm 1 will be displayed in the Operation Cycle of the device.
- **Flash in Alarm 1:** Allows you to define whether Alarm 1 will display an alert flag on the display when it is in an alarm situation (see [DISPLAY INFORMATION](#) section).

## DIFFERENTIAL ALARM

- **Alarm 1 SP:** Allows you to define the trigger point for Alarm 1. Range: According to the minimum and maximum SP limits configured.
- **Alarm 1 Initial Blocking:** Allows you to define whether there will be an initial block of alarm 1 (see [ALARM INITIAL BLOCK FUNCTION](#) section).
- **Alarm 1 Hysteresis:** Allows you to define a hysteresis value for Alarm 1.
- **T1 of Alarm 1:** Allows you to define a timer interval for the activation of Alarm 1. Range: 0 ~ 5999 (in seconds).
- **T2 of Alarm 1:** Allows you to define a second timer interval for the activation of Alarm 1. Range: 0 ~ 5999 (in seconds).
- **Displays SPA1 in the Operation Cycle:** Allows you to define whether the SPA1 of Alarm 1 will be displayed in the Operation Cycle of the device.
- **Flash in Alarm 1:** Allows you to define whether Alarm 1 will display an alert flag on the display when it is in an alarm situation (see [DISPLAY INFORMATION](#) section).

## MINIMUM DIFFERENTIAL ALARM

- **Alarm 1 SP:** Allows you to define the trigger point for Alarm 1. Range: According to the minimum and maximum SP limits configured.
- **Alarm 1 Initial Blocking:** Allows you to define whether there will be an initial block of alarm 1 (see [ALARM INITIAL BLOCK FUNCTION](#) section).
- **Alarm 1 Hysteresis:** Allows you to define a hysteresis value for Alarm 1.
- **T1 of Alarm 1:** Allows you to define a time interval for triggering Alarm 1. Range: 0 ~ 5999 (in seconds).
- **T2 of Alarm 1:** Allows you to define a second time interval for triggering Alarm 1. Range: 0 ~ 5999 (in seconds).
- **Displays SPA1 in the Operation Cycle:** Allows you to define whether the Alarm 1 SPA1 will be displayed in the Operation Cycle of the device.
- **Flash in Alarm 1:** Allows you to define whether Alarm 1 will display an alert flag on the display when it is in an alarm situation (see [DISPLAY INFORMATION](#) section).

## MAXIMUM DIFFERENTIAL ALARM

- **Alarm 1 SP:** Allows you to define the trigger point for Alarm 1. Range: According to the minimum and maximum SP limits configured.
- **Alarm 1 Initial Blocking:** Allows you to define whether there will be an initial block of alarm 1 (see [ALARM INITIAL BLOCK FUNCTION](#) section).
- **Alarm 1 Hysteresis:** Allows you to define a hysteresis value for Alarm 1.
- **T1 of Alarm 1:** Allows you to define a time interval for triggering Alarm 1. Range: 0 ~ 5999 (in seconds).
- **T2 of Alarm 1:** Allows you to define a second time interval for triggering Alarm 1. Range: 0 ~ 5999 (in seconds).
- **Displays SPA1 in the Operation Cycle:** Allows you to define whether the Alarm 1 SPA1 will be displayed in the Operation Cycle of the device.
- **Flash in Alarm 1:** Allows you to define whether Alarm 1 will display an alert flag on the display when it is in an alarm situation (see [DISPLAY INFORMATION](#) section).

## OPEN SENSOR ALARM

- **T1 of Alarm 1:** Allows you to define a time interval for triggering Alarm 1. Range: 0 ~ 5999 (in seconds).
- **T2 of Alarm 1:** Allows you to define a second time interval for triggering Alarm 1. Range: 0 ~ 5999 (in seconds).
- **Flash in Alarm 1:** Allows you to define whether Alarm 1 will display an alert flag on the display when it is in an alarm situation (see [DISPLAY INFORMATION](#) section).

## RAMPS AND SOAKS EVENT ALARM

- **T1 of Alarm 1:** Allows you to define a time interval for triggering Alarm 1. Range: 0 ~ 5999 (in seconds).
- **T2 of Alarm 1:** Allows you to define a second time interval for triggering Alarm 1. Range: 0 ~ 5999 (in seconds).
- **Flash in Alarm 1:** Allows you to define whether Alarm 1 will display an alert flag on the display when it is in an alarm situation (see [DISPLAY INFORMATION](#) section).

## OPEN LOOP ALARM

- **T1 of Alarm 1:** Allows you to define a time interval for triggering Alarm 1. Range: 0 ~ 5999 (in seconds).
- **T2 of Alarm 1:** Allows you to define a second time interval for triggering Alarm 1. Range: 0 ~ 5999 (in seconds).
- **Flash in Alarm 1:** Allows you to define whether Alarm 1 will display an alert flag on the display when it is in an alarm situation (see [DISPLAY INFORMATION](#) section).
- **LBD Time for Alarm 1:** Allows you to define an LBD time for Alarm 1 (see [LOOP BREAK DETECTION \(LBD\) FUNCTION](#) section).

### 7.3.2.6 RnS PROGRAMS

This tab allows you to configure the parameters related to the programs:

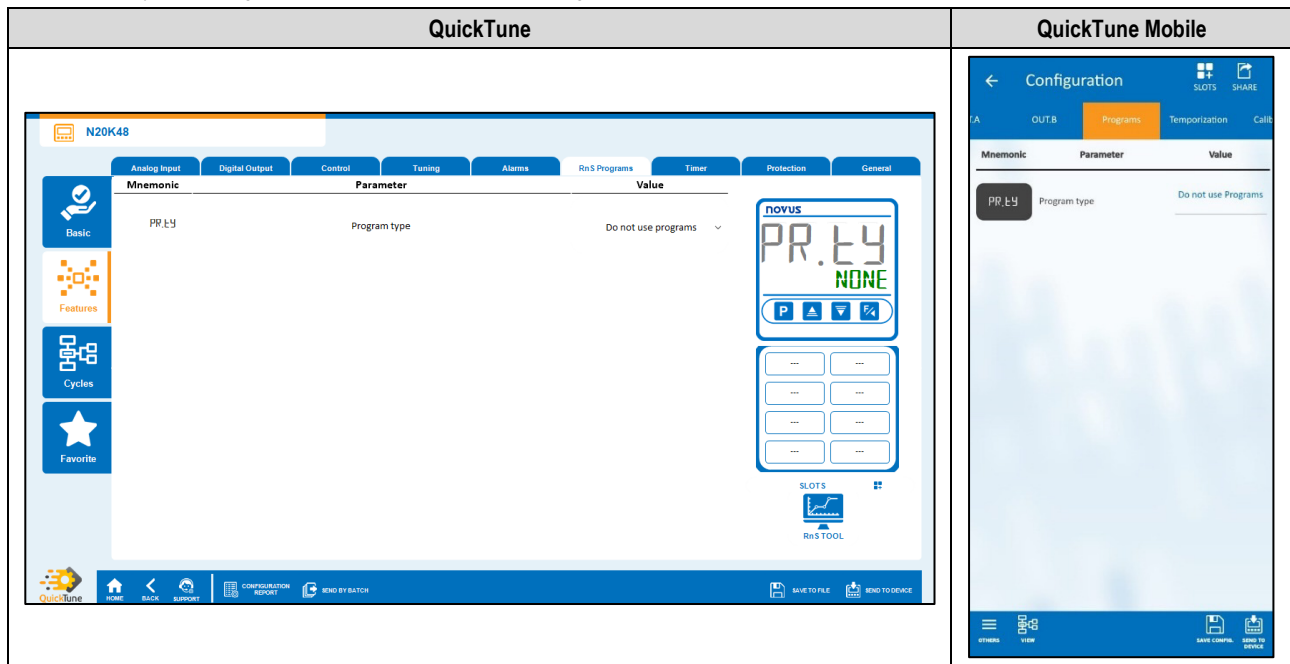

Figure 45 – RnS Programs tab

- **Program Type:** Allows you to define the type of program to be used: “Do not use programs”, “Ramp and Soak” or “Ramp and Soak Program” (see [RAMPS AND SOAKS PROGRAMS](#) chapter).

#### PARAMETERS OF EACH PROGRAM:

Each type of program has specific parameters.

#### RAMP AND SOAK

- **Maximum rate of Setpoint evolution:** Allows you to define a maximum Setpoint evolution rate. Range: 0 ~ 100.
- **Dwell time at the Setpoint:** Allows you to define a dwell time at the Setpoint. Range: 0 ~ 9999.

#### RAMP AND SOAK PROGRAM

- **Time base for programs:** Allows you to define a time base for the programs you create: “Minutes:Seconds” or “Hours:Minutes”.
- **Type of program resumption in case of power failure:** Allows you to define the type of program resumption in case of power failure: “Resumes at the beginning of the program”, “Resumes at the beginning of the segment”, “Resumes at the exact point where it stopped”, or “Resumes with control disabled (RUN = No)”.
- **Program Number being Edited:** Allows you to define the number of the program to be edited. The controller allows up to a maximum of 20 programs (see [RAMPS AND SOAKS PROGRAMS](#) chapter).
- **Program Tolerance:** Allows you to define the maximum deviation to be allowed between the program PV and SP. If exceeded, the program is suspended (stops counting time) until the deviation is within the tolerance set in this parameter. If set to 0, the program progresses regardless of the difference between PV and SP.
- **Program Setpoint 0-9:** Allows you to define a Setpoint for the configured program (From Setpoint 1 to Setpoint 9).
- **Segment 1-9 Event:** Allows you to define which alarms are to be triggered during a program segment (From Segment 1 to Segment 9). Available only for alarms whose parameter **Alarm Function 1-4** (Alarms tab) have been configured with the “Event” function.
- **Segment 1-9 Duration:** Allows you to define the duration of each of the 9 segments of the configured program (From Segment 1 to Segment 9). Range: 99:59 (in minutes) or 0 to 9999 (in seconds), as configured in the **Program Time Base** parameter.
- **Program Link:** Allows you to create a connection between programs, using the number of the program you want to connect to. At the end of the running program, any other program can start immediately. If set to 0, it means that there is no connection configured. See [PROGRAM LINK](#) section.

#### RnS TOOL SECTION:

QuickTune has a RnS Tool, which facilitates the process of creating Ramps and Soaks programs. To use it, simply click the icon below:



Figure 46 – RnS Tool icon

For more specific information on how this tool works, please refer to the software manual.

### 7.3.2.7 TIMER

This tab allows you to configure the parameters related to the timers:

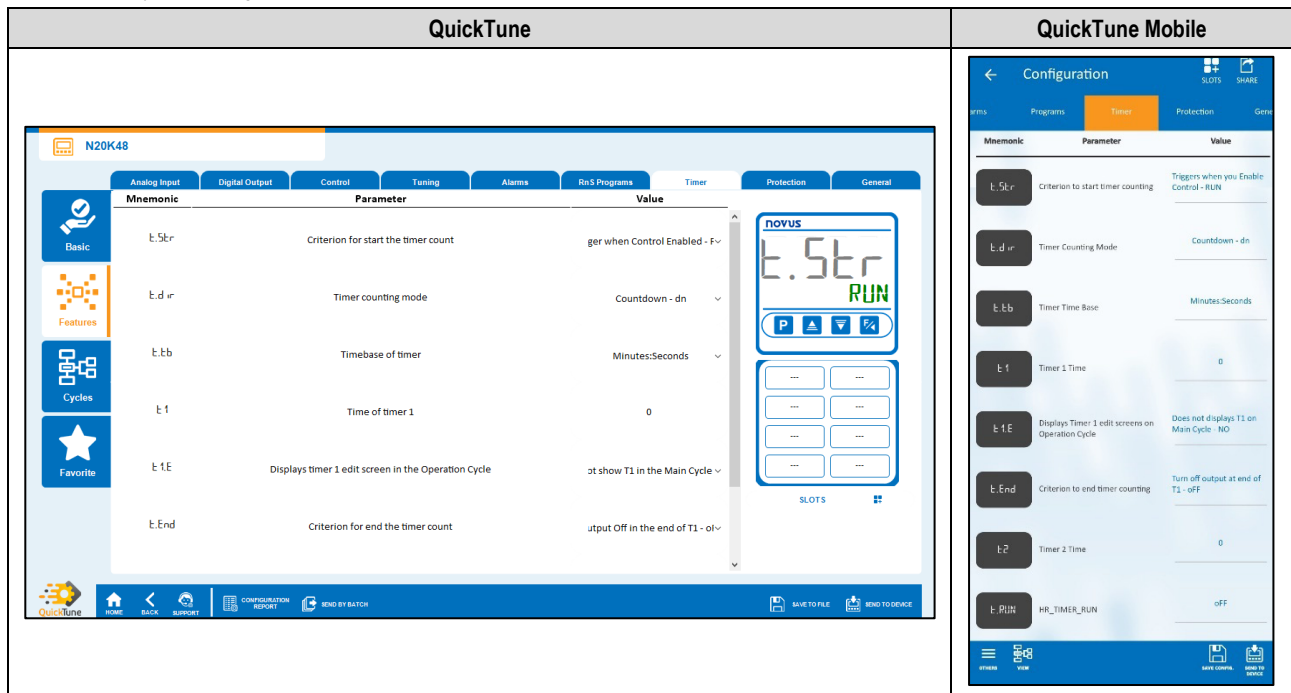

Figure 47 – Timer tab

- **Criterion for starting the timer counting:** Allows you to define a criterion to start the timer counting: “Disabled Timer”, “Triggers when PV=SP”, “Triggers when press F key”, “Triggers when Control Enabled” or “Triggers with DI” (see [ALARM TIMER](#) section).
- **Timer counting mode:** Allows you to define the timer counting mode: “Forward (UP)” or “Backward (DN)”.
- **Timer time base:** Allows you to define the timer time base: “Minutes:Seconds” or “Hours:Minutes”.
- **Time of timer 1:** Allows you to define the timer 1 time. Range: 99:59 (in minutes) or 0 to 9999 (in seconds), as configured in the **Timer Time Base** parameter.
- **Displays timer 1 edit screen in the Operation Cycle:** If enabled, the timer 1 editing screen will be displayed in the Operation Cycle of the device.
- **Criterion for ending the timer counting:** Allows you to define a criterion for ending the timer counting: “Output off at the end of T1” or “Output on at the end of T1”.
- **Time of timer 2:** Allows you to define the timer 2 time. Range: 99:59 (in minutes) or 0 to 9999 (in seconds), as configured in the **Timer Time Base** parameter.

### 7.3.2.8 PROTECTION

This tab allows you to configure the parameters related to the protection:

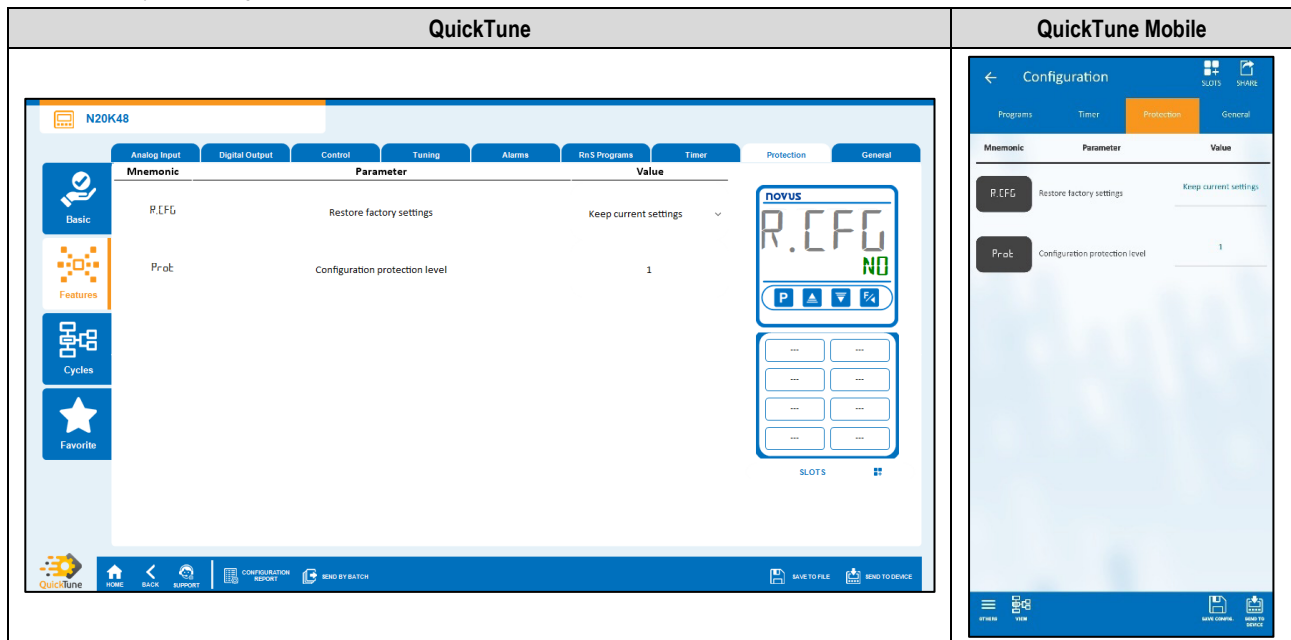

Figure 48 – Protection tab

- **Restore factory settings:** Allows you to define whether the device will keep the current configuration: “Keeps current settings” or “Restores factory settings”.
- **Configuration protection level:** Allows you to define the protection level to be used (see [CONFIGURATION PROTECTION](#) section).

### 7.3.2.9 GENERAL

This tab allows you to configure the general parameters:

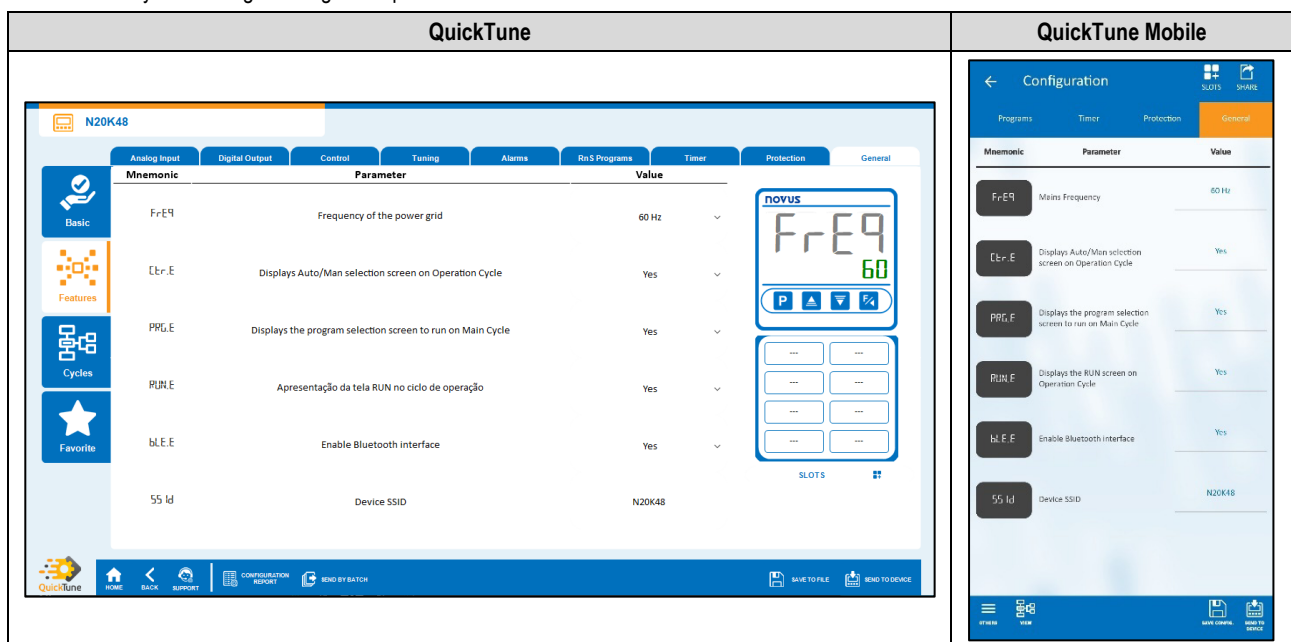

Figure 49 – General tab

- **Frequency of the power grid:** Allows you to define the mains frequency: 50 or 60 Hz.
- **Displays Auto/Man selection screen on Operation Cycle:** If enabled, the Automatic/Manual Control Mode selection screen will be displayed in the Operation Cycle of the device.
- **Displays the program selection screen to run on Main Cycle:** If enabled, the selection screen of the program to be executed will be displayed in the Operation Cycle of the device.
- **Displays RUN screen on Operation Cycle:** If enabled, the **RUN** parameter will be displayed in the Operation Cycle of the device.
- **Enables Bluetooth interface:** Allows you to enable the Bluetooth interface.
- **Device SSID:** Allows you to define a SSID for the device. Up to a limit of 8 characters.

### 7.3.3 CYCLES

This screen is divided into tabs and allows you to view the features grouped by feature cycles. Information regarding ClickNGo modules can be viewed in the specific module datasheet.

#### 7.3.3.1 OPERATION

This tab groups all the parameters related to the Operation Cycle of the device:

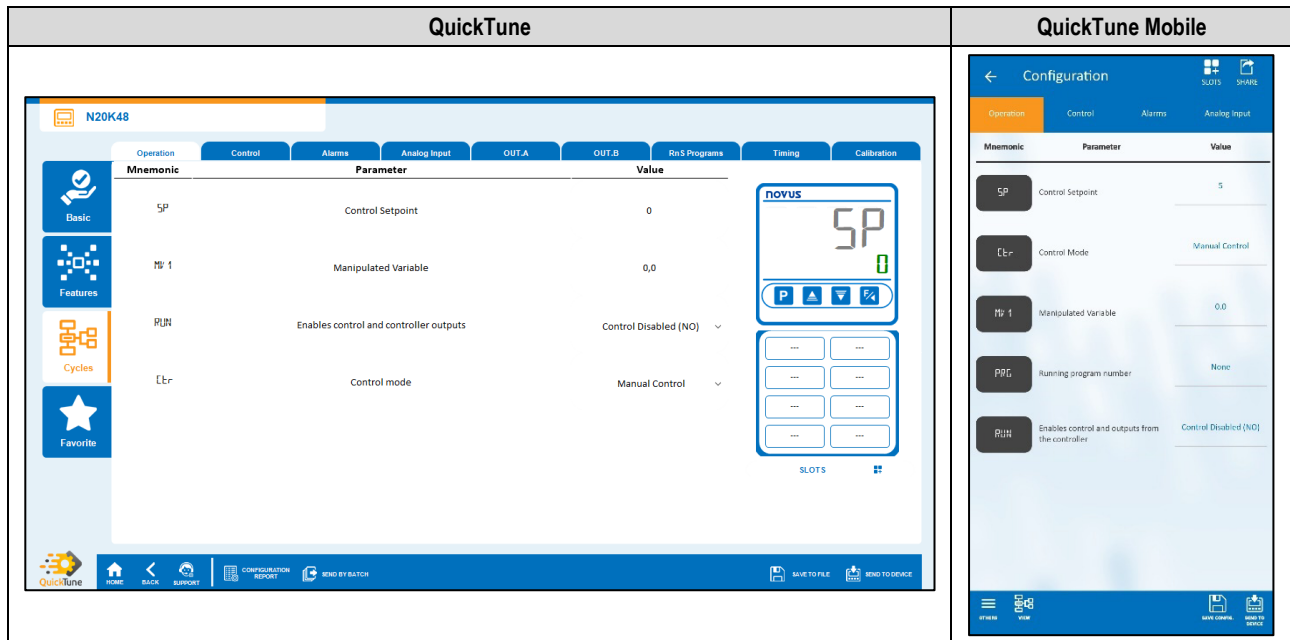

Figure 50 – Operation tab

- **Control Setpoint:** Allows you to define the control Setpoint, according to the minimum and maximum limits of the configured SP.
- **Manipulated Variable:** Allows you to define the value of the manipulated variable. Range: 0 ~ 100.
- **Enables control and controller outputs:** Allows you to enable control and outputs.
- **Control Mode:** Allows you to define the control mode of the device: “Manual” or “Automatic” (see [CONTROL MODES](#) section).

#### 7.3.3.2 CONTROL

This tab groups the parameters related to the Control Cycle (Ctrl >> Ctrl) of the device (see [CONTROL CYCLE](#) section):

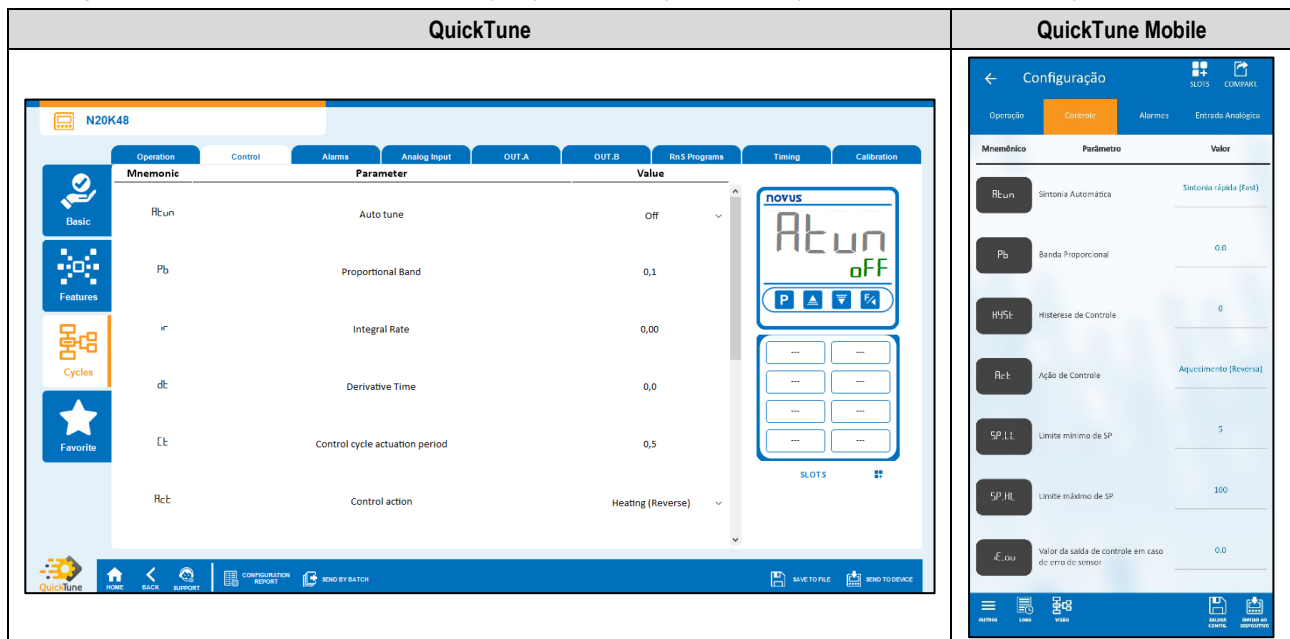

Figure 51 – Control tab

- **Auto-Tuning:** Allows you to define the auto-tuning mode: “Off”, “Fast tuning”, “Precise tuning”, “Precise and auto-adaptative tuning”, “New precise and auto-adaptative tuning”, “New precise and auto-adaptative tuning when RUN = YES” (see [PID PARAMETERS](#) chapter).
- **Proportional Band:** Allows you to define the proportional band. It refers to the P value of the PID control mode, as a percentage of the input type maximum range. **When set to 0.0, determines the ON/OFF control mode.** Range: 0 ~ 500.
- **Integral Rate:** Allows you to define the integral rate. It refers to the I value of the PID control mode, in repetitions per minute (Reset). Available only when the **Proportional Band** parameter is  $\neq 0$ . Range: 0 ~ 99.99 (in seconds).

- **Derivative Time:** Allows you to define the derivative time. It refers to the **D** value of the PID control mode, in seconds. Available only when the **Proportional Band** parameter is  $\neq 0$ . Range: 0 ~ 300,0 (in seconds).
- **Control cycle action period:** Allows you to define the PWM cycle value. Available only when the **Proportional Band** parameter is  $\neq 0$ . Range: 0,5 ~ 100,0 (in seconds).
- **Control Action:** Allows you to enable the control logic to be used: “Heating (Reverse)”, which turns on the control output when the PV is below SP, or “Cooling (Direct)”, which turns on the control output when the PV is above SP. Only available for “Automatic” control mode.
- **Control Hysteresis:** Allows you to define a hysteresis value for ON/OFF control mode (To define an ON/OFF control mode, the **Proportional Band** parameter of the Tuning tab must be set to 0.0). Adjustable between 0 and the measurement range width of the selected input type.
- **Lower limit of SP:** Allows you to define the lower limit for the Setpoint adjustment. Allows you to define the minimum value of the PV indication range and limit the SP adjustment of the available **linear analog signal inputs** (0-20 mA, 4-20 mA, 0-50 mV, 0-5 V and 0-10 V).
- **Upper limit of SP:** Allows you to define the upper limit for the Setpoint adjustment. Allows you to define the maximum value of the PV indication range and limit the SP adjustment of the available **linear analog signal inputs** (0-20 mA, 4-20 mA, 0-50 mV, 0-5 V and 0-10 V).
- **Control output value in case of sensor error:** Allows you to define a specific value for the control output in case of sensor error.

### 7.3.3.3 ALARMS

This tab groups the parameters related to the Alarm Cycle (**CFG >> RLM**) of the device (see [ALARM CYCLE](#) section):

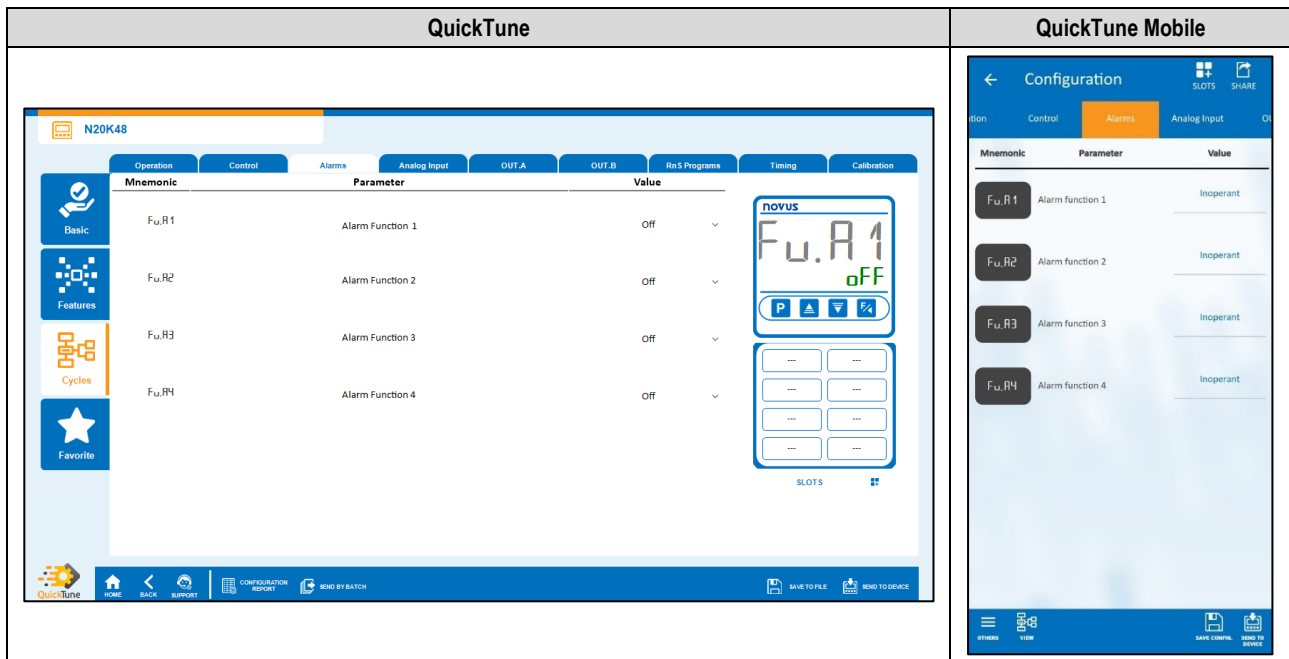

Figure 52 – Alarms cycle

- **Alarm 1 Function:** Allows you to define alarm 1 function: “Off”, “Minimum”, “Maximum”, “Differential”, “Minimum Differential”, “Maximum Differential”, “Open Sensor”, “Ramps and Soaks Event”, “End of Soak” or “Open Loop” (see [ALARM CONFIGURATION](#) section).
- **Alarm 2 Function:** Allows you to define alarm 2 function: “Off”, “Minimum”, “Maximum”, “Differential”, “Minimum Differential”, “Maximum Differential”, “Open Sensor”, “Ramps and Soaks Event”, “End of Soak” or “Open Loop” (see [ALARM CONFIGURATION](#) section).
- **Alarm 3 Function:** Allows you to define alarm 3 function: “Off”, “Minimum”, “Maximum”, “Differential”, “Minimum Differential”, “Maximum Differential”, “Open Sensor”, “Ramps and Soaks Event”, “End of Soak” or “Open Loop” (see [ALARM CONFIGURATION](#) section).
- **Alarm 4 Function:** Allows you to define alarm 4 function: “Off”, “Minimum”, “Maximum”, “Differential”, “Minimum Differential”, “Maximum Differential”, “Open Sensor”, “Ramps and Soaks Event”, “End of Soak” or “Open Loop” (see [ALARM CONFIGURATION](#) section).

### PARAMETERS OF EACH ALARM:

Each type of alarm has specific parameters. The sections below present the configuration parameters for Alarm 1 function modes, but all alarms have the same parameters.

#### MINIMUM ALARM

- **Alarm 1 SP:** Allows you to define the trigger point for Alarm 1. Range: According to the minimum and maximum SP limits configured.
- **Alarm 1 Initial Blocking:** Allows you to define whether there will be an initial block of alarm 1 (see [ALARM INITIAL BLOCK FUNCTION](#) section).
- **Alarm 1 Hysteresis:** Allows you to define a hysteresis value for Alarm 1.
- **T1 of Alarm 1:** Allows you to define a timer interval for the activation of Alarm 1. Range: 0 ~ 5999 (in seconds).
- **T2 of Alarm 1:** Allows you to define a second timer interval for the activation of Alarm 1. Range: 0 ~ 5999 (in seconds).
- **Displays SPA1 in the Operation Cycle:** Allows you to define whether the SPA1 of Alarm 1 will be displayed in the Operation Cycle of the device.
- **Flash in Alarm 1:** Allows you to define whether Alarm 1 will display an alert flag on the display when it is in an alarm situation (see [DISPLAY INFORMATION](#) section).

## MAXIMUM ALARM

- **Alarm 1 SP:** Allows you to define the trigger point for Alarm 1. Range: According to the minimum and maximum SP limits configured.
- **Alarm 1 Initial Blocking:** Allows you to define whether there will be an initial block of alarm 1 (see [ALARM INITIAL BLOCK FUNCTION](#) section).
- **Alarm 1 Hysteresis:** Allows you to define a hysteresis value for Alarm 1.
- **T1 of Alarm 1:** Allows you to define a timer interval for the activation of Alarm 1. Range: 0 ~ 5999 (in seconds).
- **T2 of Alarm 1:** Allows you to define a second timer interval for the activation of Alarm 1. Range: 0 ~ 5999 (in seconds).
- **Displays SPA1 in the Operation Cycle:** Allows you to define whether the SPA1 of Alarm 1 will be displayed in the Operation Cycle of the device.
- **Flash in Alarm 1:** Allows you to define whether Alarm 1 will display an alert flag on the display when it is in an alarm situation (see [DISPLAY INFORMATION](#) section).

## DIFFERENTIAL ALARM

- **Alarm 1 SP:** Allows you to define the trigger point for Alarm 1. Range: According to the minimum and maximum SP limits configured.
- **Alarm 1 Initial Blocking:** Allows you to define whether there will be an initial block of alarm 1 (see [ALARM INITIAL BLOCK FUNCTION](#) section).
- **Alarm 1 Hysteresis:** Allows you to define a hysteresis value for Alarm 1.
- **T1 of Alarm 1:** Allows you to define a timer interval for the activation of Alarm 1. Range: 0 ~ 5999 (in seconds).
- **T2 of Alarm 1:** Allows you to define a second timer interval for the activation of Alarm 1. Range: 0 ~ 5999 (in seconds).
- **Displays SPA1 in the Operation Cycle:** Allows you to define whether the SPA1 of Alarm 1 will be displayed in the Operation Cycle of the device.
- **Flash in Alarm 1:** Allows you to define whether Alarm 1 will display an alert flag on the display when it is in an alarm situation (see [DISPLAY INFORMATION](#) section).

## MINIMUM DIFFERENTIAL ALARM

- **Alarm 1 SP:** Allows you to define the trigger point for Alarm 1. Range: According to the minimum and maximum SP limits configured.
- **Alarm 1 Initial Blocking:** Allows you to define whether there will be an initial block of alarm 1 (see [ALARM INITIAL BLOCK FUNCTION](#) section).
- **Alarm 1 Hysteresis:** Allows you to define a hysteresis value for Alarm 1.
- **T1 of Alarm 1:** Allows you to define a time interval for triggering Alarm 1. Range: 0 ~ 5999 (in seconds).
- **T2 of Alarm 1:** Allows you to define a second time interval for triggering Alarm 1. Range: 0 ~ 5999 (in seconds).
- **Displays SPA1 in the Operation Cycle:** Allows you to define whether the Alarm 1 SPA1 will be displayed in the Operation Cycle of the device.
- **Flash in Alarm 1:** Allows you to define whether Alarm 1 will display an alert flag on the display when it is in an alarm situation (see [DISPLAY INFORMATION](#) section).

## MAXIMUM DIFFERENTIAL ALARM

- **Alarm 1 SP:** Allows you to define the trigger point for Alarm 1. Range: According to the minimum and maximum SP limits configured.
- **Alarm 1 Initial Blocking:** Allows you to define whether there will be an initial block of alarm 1 (see [ALARM INITIAL BLOCK FUNCTION](#) section).
- **Alarm 1 Hysteresis:** Allows you to define a hysteresis value for Alarm 1.
- **T1 of Alarm 1:** Allows you to define a time interval for triggering Alarm 1. Range: 0 ~ 5999 (in seconds).
- **T2 of Alarm 1:** Allows you to define a second time interval for triggering Alarm 1. Range: 0 ~ 5999 (in seconds).
- **Displays SPA1 in the Operation Cycle:** Allows you to define whether the Alarm 1 SPA1 will be displayed in the Operation Cycle of the device.
- **Flash in Alarm 1:** Allows you to define whether Alarm 1 will display an alert flag on the display when it is in an alarm situation (see [DISPLAY INFORMATION](#) section).

## OPEN SENSOR ALARM

- **T1 of Alarm 1:** Allows you to define a time interval for triggering Alarm 1. Range: 0 ~ 5999 (in seconds).
- **T2 of Alarm 1:** Allows you to define a second time interval for triggering Alarm 1. Range: 0 ~ 5999 (in seconds).
- **Flash in Alarm 1:** Allows you to define whether Alarm 1 will display an alert flag on the display when it is in an alarm situation (see [DISPLAY INFORMATION](#) section).

## RAMPS AND SOAKS EVENT ALARM

- **T1 of Alarm 1:** Allows you to define a time interval for triggering Alarm 1. Range: 0 ~ 5999 (in seconds).
- **T2 of Alarm 1:** Allows you to define a second time interval for triggering Alarm 1. Range: 0 ~ 5999 (in seconds).
- **Flash in Alarm 1:** Allows you to define whether Alarm 1 will display an alert flag on the display when it is in an alarm situation (see [DISPLAY INFORMATION](#) section).

## OPEN LOOP ALARM

- **T1 of Alarm 1:** Allows you to define a time interval for triggering Alarm 1. Range: 0 ~ 5999 (in seconds).



- **T2 of Alarm 1:** Allows you to define a second time interval for triggering Alarm 1. Range: 0 ~ 5999 (in seconds).
- **Flash in Alarm 1:** Allows you to define whether Alarm 1 will display an alert flag on the display when it is in an alarm situation (see [DISPLAY INFORMATION](#) section).
- **LBD Time for Alarm 1:** Allows you to define an LBD time for Alarm 1 (see [LOOP BREAK DETECTION \(LBD\) FUNCTION](#) section).

### 7.3.3.4 ANALOG INPUT

This tab groups the parameters related to the Analog Input Cycle (**[F] >> IN**) of the device (see [INPUT CYCLE](#) section):

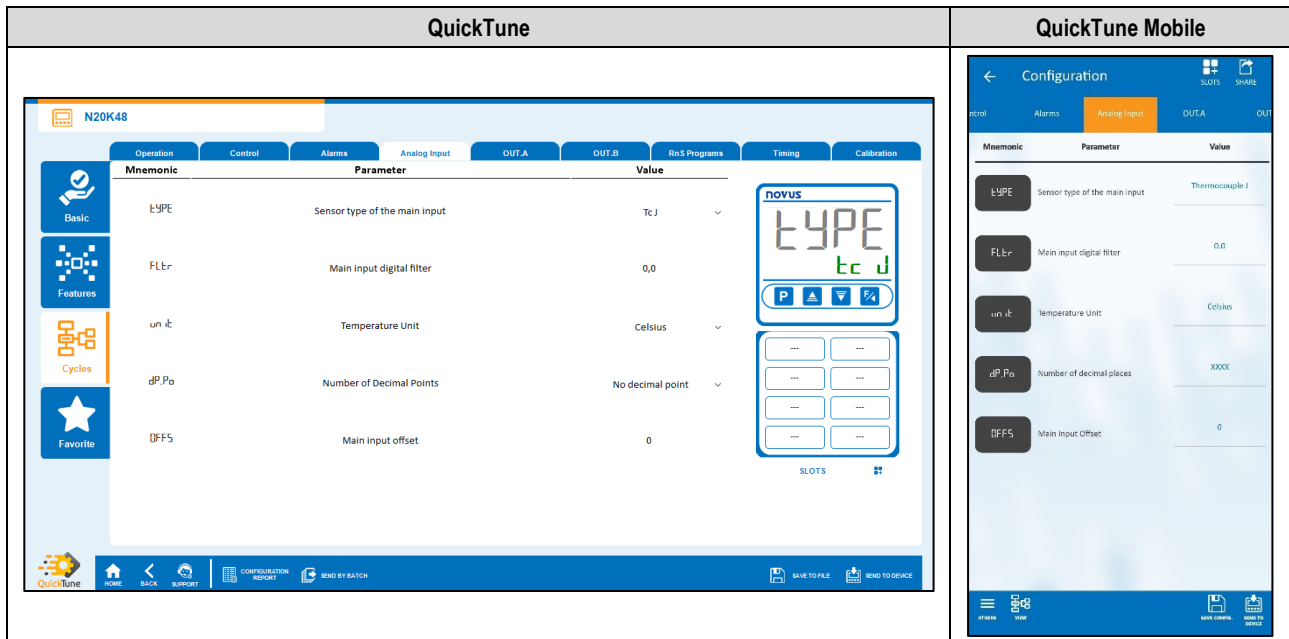

Figure 53 – Analog input cycle

- **Sensor type of the main input:** Allows you to define the sensor type of the main input (see [ANALOG INPUT CONFIGURATION](#) section).
- **Main input digital filter:** Allows you to define a filter for the main input. Used to improve the stability of the measured signal (PV). Adjustable between 0 and 999.9. At 0, it means that the filter is off. At 999.9, it means the filter is at maximum. The larger the filter, the slower the response of the measured value.
- **Temperature Unit:** Allows you to define the temperature unit to be used: “Celsius” or “Fahrenheit”.
- **Decimal Places:** Allows you to define the number of decimal places to be used when displaying SP and PV values: “No decimal places” or “One decimal place”.
- **Offset of the main input:** Allows you to define the Offset value for the main input.

### 7.3.3.5 OUT.A

This tab groups the parameters related to the Output A Cycle (CFG >> OUT.A) of the device (see [OUTPUT A CYCLE](#) section):

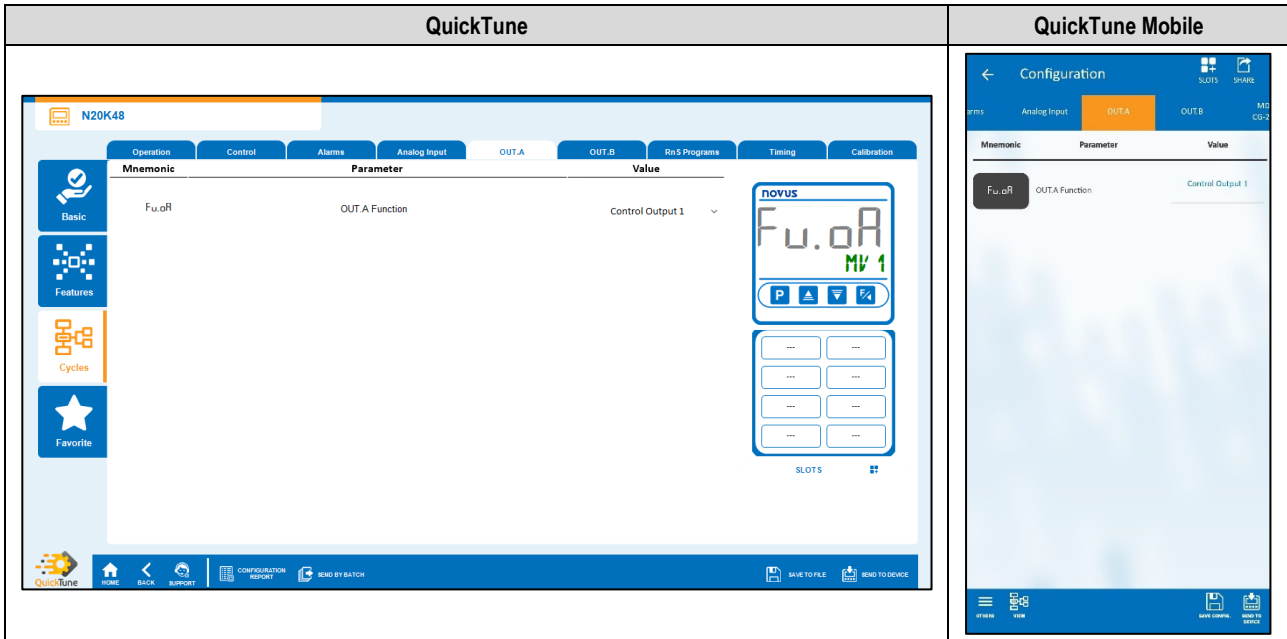

Figure 54 – OUT.A cycle

- **OUT.A Function:** Allows you to define **OUT.A** output function: “Off”, “Control Output 1”, “Control Output 2”, “Alarm 1”, “Alarm 2”, “Alarm 3”, “Alarm 4”, “Timer 1”, “Timer 2” or “Modbus-Coil” (see [OUTPUT CONFIGURATION](#) section).

### 7.3.3.6 OUT.B

This tab groups the parameters related to the Output B Cycle (CFG >> OUT.B) of the device (see [OUTPUT B CYCLE](#) section):

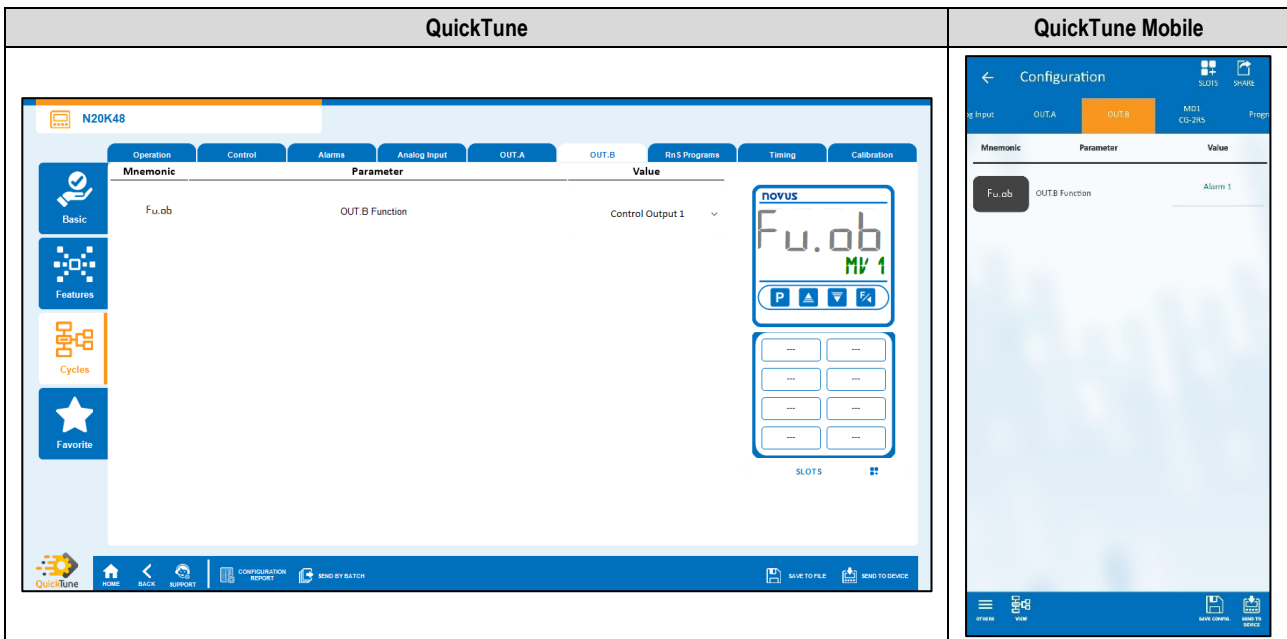

Figure 55 – OUT.B cycle

- **OUT.B Function:** Allows you to define **OUT.B** output function: “Off”, “Control Output 1”, “Control Output 2”, “Alarm 1”, “Alarm 2”, “Alarm 3”, “Alarm 4”, “Timer 1”, “Timer 2” or “Modbus-Coil” (see [OUTPUT CONFIGURATION](#) section).

### 7.3.3.7 RnS PROGRAMS

This tab groups the parameters related to the Program Cycle (CFG >> PROG) of the device (see PROGRAM CYCLE section):

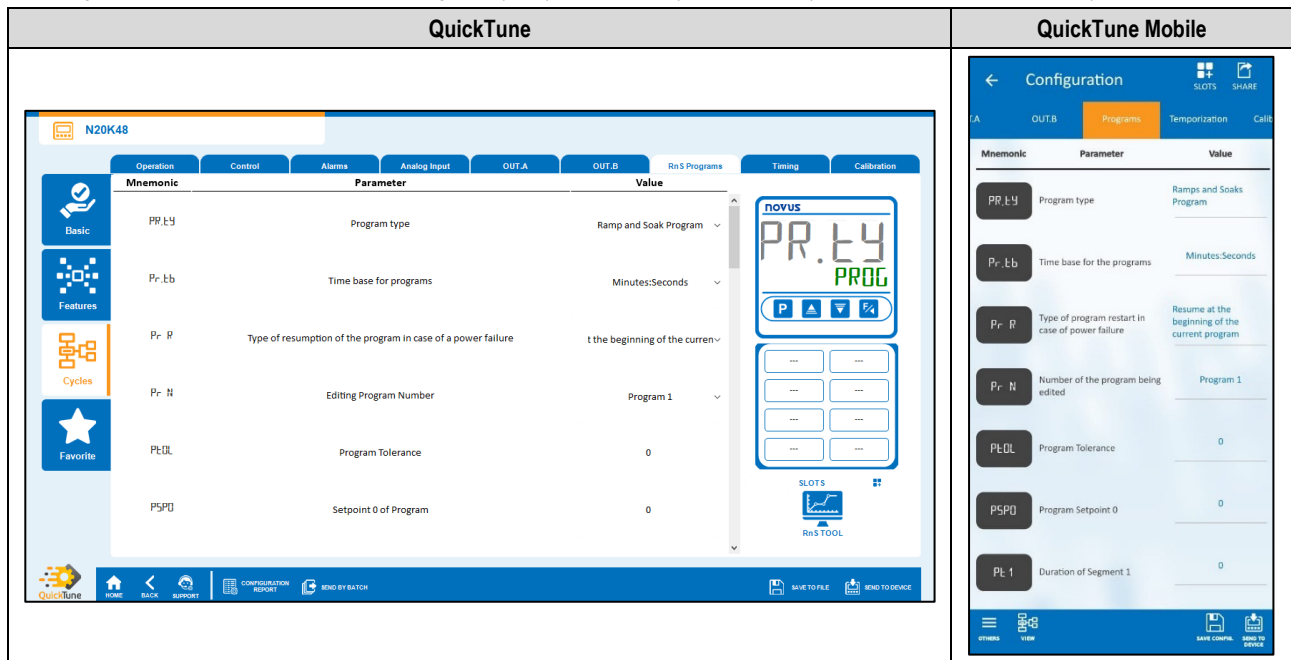

Figure 56 – Programs tab

- **Program Type:** Allows you to define the type of program to be used: “Do not use programs”, “Ramp and Soak” or “Ramp and Soak Program” (see RAMPS AND SOAKS PROGRAMS section).

#### PARAMETERS OF EACH PROGRAM:

Each type of program has specific parameters.

#### RAMP AND SOAK

- **Maximum rate of Setpoint evolution:** Allows you to define a maximum Setpoint evolution rate. Range: 0 ~ 100.
- **Dwell time at the Setpoint:** Allows you to define a dwell time at the Setpoint. Range: 0 ~ 9999.

#### RAMP AND SOAK PROGRAM

- **Time base for programs:** Allows you to define a time base for the programs you create: “Minutes:Seconds” or “Hours:Minutes”.
- **Type of program resumption in case of power failure:** Allows you to define the type of program resumption in case of power failure: “Resumes at the beginning of the program”, “Resumes at the beginning of the segment”, “Resumes at the exact point where it stopped”, or “Resumes with control disabled (RUN = No)”.
- **Program Number being Edited:** Allows you to define the number of the program to be edited. The controller allows up to a maximum of 20 programs (see RAMPS AND SOAKS PROGRAMS chapter).
- **Program Tolerance:** Allows you to define the maximum deviation to be allowed between the program PV and SP. If exceeded, the program is suspended (stops counting time) until the deviation is within the tolerance set in this parameter. If set to 0, the program progresses regardless of the difference between PV and SP.
- **Program Setpoint 0-9:** Allows you to define a setpoint for the configured program (From Setpoint 1 to Setpoint 9).
- **Segment 1-9 Event:** Allows you to define which alarms are to be triggered during a program segment (From Segment 1 to Segment 9). Available only for alarms whose parameter **Alarm Function 1-4** (Alarms tab) have been configured with the “Event” function.
- **Segment 1-9 Duration:** Allows you to define the duration of each of the 9 segments of the configured program (From Segment 1 to Segment 9). Range: 99:59 (in minutes) or 0 to 9999 (in seconds), as configured in the **Program Time Base** parameter.
- **Program Link:** Allows you to create a connection between programs, using the number of the program you want to connect to. At the end of the running program, any other program can start immediately. If set to 0, it means that there is no connection configured. See PROGRAM LINK section.

#### RnS TOOL SECTION:

QuickTune has the RnS Tool, which facilitates the process of creating Ramps and Soaks programs. To use it, simply click the icon below:



Figure 57 – RnS Tool icon

For more specific information on how this tool works, please refer to the software manual.

### 7.3.3.8 TIMING

This tab groups the parameters related to the Timer Cycle (CFG >> EM) of the device (see [TIMER CYCLE](#) section):

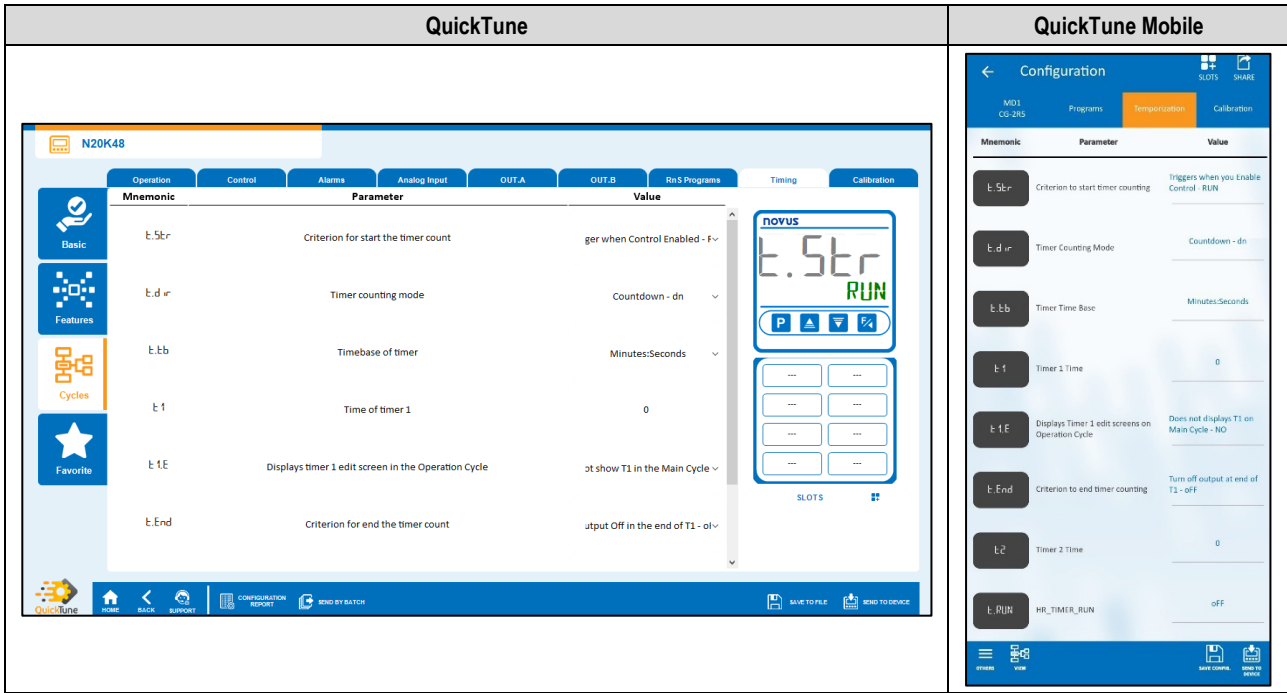

Figure 58 – Timer cycle

- **Criterion for starting the timer counting:** Allows you to define a criterion to start the timer counting: “Disabled Timer”, “Triggers when PV=SP”, “Triggers when press F key”, “Triggers when Control Enabled” or “Triggers with DI” (see ALARM TIMER section).
- **Timer counting mode:** Allows you to define the timer counting mode: “Forward (UP)” or “Backward (DN)”.
- **Timer time base:** Allows you to define the timer time base: “Minutes:Seconds” or “Hours:Minutes”.
- **Time of timer 1:** Allows you to define the timer 1 time. Range: 99:59 (in minutes) or 0 to 9999 (in seconds), as configured in the **Timer Time Base** parameter.
- **Displays timer 1 edit screen in the Operation Cycle:** If enabled, the timer 1 editing screen will be displayed in the Operation Cycle of the device.
- **Criterion for ending the timer counting:** Allows you to define a criterion for ending the timer counting: “Output off at the end of T1” or “Output on at the end of T1”.
- **Time of timer 2:** Allows you to define the timer 2 time. Range: 99:59 (in minutes) or 0 to 9999 (in seconds), as configured in the **Timer Time Base** parameter.

### 7.3.3.9 CALIBRATION

This tab groups the parameters related to the Calibration Cycle (CFG >> CAL ib) of the device (see [CALIBRATION CYCLE](#) section):

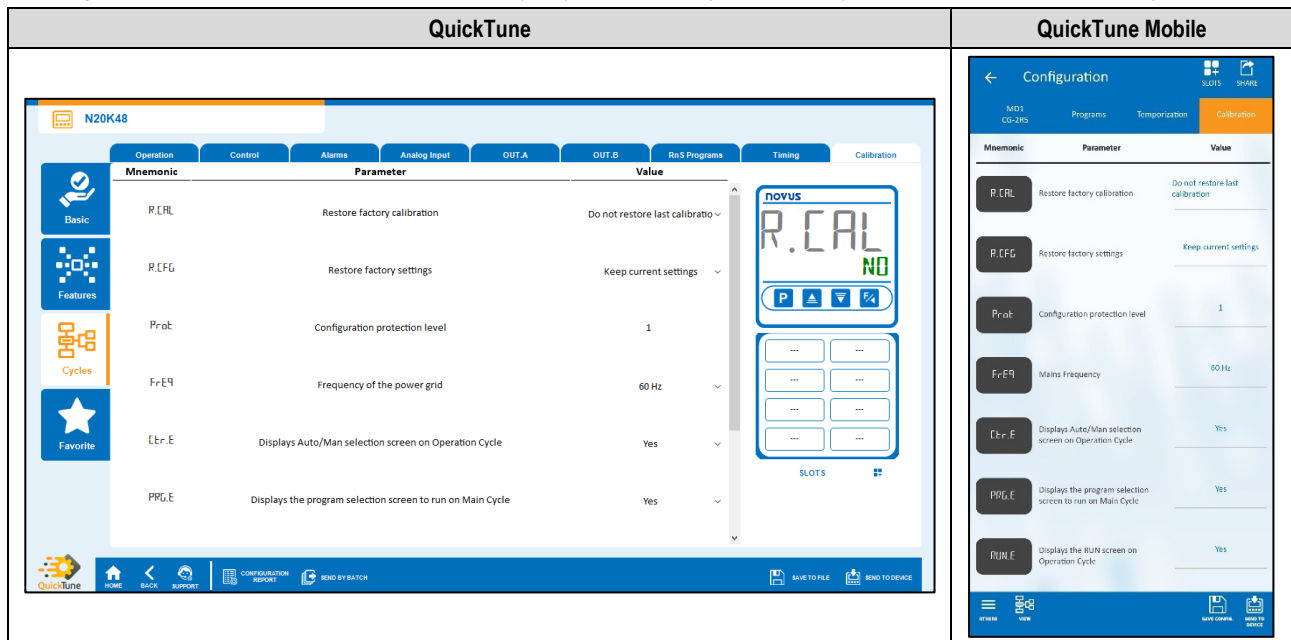

Figure 59 – Calibration cycle

- **Restore factory settings:** Allows you to define whether the device will keep the current configuration: “Keeps current settings” or “Restores factory settings”.
- **Restore factory calibration:** Allows you to define whether the device will keep the current calibration: “Keep current calibration” or “Restore factory calibration”.
- **System Password:** Allows you to enter the system password (see [PASSWORD](#) section).
- **Configuration protection level:** Allows you to define the protection level to be used (see [CONFIGURATION PROTECTION](#) section).
- **Frequency of the power grid:** Allows you to define the mains frequency: 50 or 60 Hz.
- **Displays Auto/Man selection screen on Operation Cycle:** If enabled, the Automatic/Manual Control Mode selection screen will be displayed in the Operation Cycle of the device.
- **Displays the program selection screen to run on Main Cycle:** If enabled, the selection screen of the program to be executed will be displayed in the Operation Cycle of the device.
- **Displays RUN screen on Operation Cycle:** If enabled, the **RUN** parameter will be displayed in the Operation Cycle of the device.
- **Enables Bluetooth interface:** Allows you to enable the Bluetooth interface.
- **Device SSID:** Allows you to define a SSID for the device. Up to a limit of 8 characters.

### 7.3.4 FAVORITE

This screen allows you to create favorite settings for the device. This makes it easy to make changes later. See the software manual for more information.

**8.1 CONTROLLER ISSUES**







Wiring errors and improper programming represent most of the problems presented when using the controller. A final review can avoid wasted time and losses.

The device has an alarm function, called **Input Error**, which is used to report specific errors at the input. In the [INPUT ERROR TYPES](#) section you will find a table with a description of the problems and the messages shown in the device display.

Other error messages displayed by the controller indicate internal damage that signals the need to send the equipment in for maintenance. When contacting the manufacturer, enter the serial number, which you can find by accessing the Calibration Cycle (**CFG >> CAL Ib**) and then the parameters Serial Number High (**SnH**) and Serial Number Low (**SnL**).

**8.2 INPUT CALIBRATION**

The input types leave the factory calibrated. Recalibration is not recommended for inexperienced operators. If it is necessary to recalibrate an input, proceed as follows:

- In the Sensor Type (**TYPE**) parameter, present in the Configuration (**CFG >> Input (IN)**) cycle, set the type of input to be calibrated.
- In parameters **IN.LL** and **IN.HL** of the Input Cycle (**CFG >> IN**), use the  and  keys to program the lower and upper display limits for the limits of the selected input type (Parameters shown only for linear inputs).
- Apply to the input terminals a signal corresponding to an indication value slightly above the lower limit.
- In the **in.LC** parameter of the Calibration Cycle (**CFG >> CAL Ib >> in.LC**), use the  and  keys to make the display indicate the expected value for the applied signal. Next, press the  key.
- Apply a signal that corresponds to a value slightly lower than the upper display limit.
- In the **in.HC** parameter of the Calibration Cycle (**CFG >> CAL Ib >> in.HC**), use the  and  keys to make the display indicate the expected value for the applied signal.
- Check the quality of the calibration. If it is not adequate, repeat the procedure.

**Note:** When checking the controller, make sure that the Pt100 excitation current required by the calibrator used is compatible with the Pt100 excitation current used in the device: 0.170 mA.

## 9 SPECIFICATIONS

FEATURES	N20K48 MODULAR CONTROLLER	
<b>Power Supply</b>	100 to 240 Vac/dc ( $\pm 10\%$ ), 50 / 60 Hz Optionally 24V: 12 to 24 Vdc / 24 Vac (-10 % / +20 %) Maximum consumption: 10 VA	
<b>Environmental Conditions</b>	Operating temperature: -20 to 60 °C (-4 to 140 °F) Relative humidity: 80 % max. @ 30 °C Reduce 3 % for each °C for temperatures above 30 °C. Internal use. Installation category II. Pollution degree 2. Altitude < 2000 m.	
<b>Input</b>	T/C, Pt100, voltage and current (according to <b>Table 1</b> ).	
	<b>Internal resolution</b>	32767 levels (15 bits)
	<b>Display resolution</b>	12000 level (from - 1999 to 9999)
	<b>Input reading rate</b>	Up to 55 per second
	<b>Accuracy *</b>	<ul style="list-style-type: none"> <li>• Thermocouples J, K, T, E: 0.2 % of span <math>\pm 1</math> °C</li> <li>• Thermocouples N, R, S, B: 0.25 % of span <math>\pm 3</math> °C</li> <li>• Pt100: 0.2 % of span</li> <li>• 0-50 mV: 0.2 % of span</li> <li>• 4-20 mA, 0-5 Vdc, 0-10 Vdc: 0.2 % of span</li> </ul>
	<b>Input Impedance</b>	0-50 mV, Pt100 and thermocouples: >10 M $\Omega$ 0-5 V: >1 M $\Omega$ 4-20 mA: 15 $\Omega$ (+2 Vdc @ 20 mA)
	<b>Pt100 Measurement</b>	3-wire type ( $\alpha=0.00385$ ) With cable length compensation and 0.170 mA excitation current.
All input and output types are factory calibrated. The thermocouples are in accordance with NBR 12771 / 99 and RTDs NBR 13773 / 97 standards.		
<b>Control Output</b>	Voltage pulse for SSR (OUT A): 5 V maximum. / 20 mA SPST-NO Relay (OUT B): 3 A / 240 Vac, general use	
<b>Communication Interfaces</b>	<ul style="list-style-type: none"> <li>• USB 2.0 Interface</li> <li>• Bluetooth Low Energy (BLE) Interface</li> </ul>	
<b>Electromagnetic Compatibility</b>	EN 61326-1:2020	
<b>Security</b>	EN 61010-1:2010 UL 61010-1/A2:2012	
<b>Protection Index</b>	<b>Frontal Panel</b>	IP65, polycarbonate - UL94 V-2
	<b>Housing</b>	IP30, ABS+PC UL94 V-0
<b>Software</b>	QuickTune (PC) QuickTune Mobile (Smartphones)	
<b>Dimensions</b>	48.8 x 48.8 x 36.7 mm (1/16 DIN)	
	<b>Panel cut-out</b>	45.2 x 45.2 mm (+0.5 -0.0 mm)
	<b>Approximated Weight</b>	70 g (without dock and modules)
<b>Operation Start-up</b>	3 seconds after connecting the device to a power supply.	
<b>Warm-up time</b>	20 minutes.	
<b>Certifications</b>	CE, UKCA, Anatel (00388-21-07089), FCC	

\* The Accuracy specification considers the elapsed warm-up time.

**Table 18** – Specifications

### 9.1 IDENTIFICATION

**N20K48:** Model with power supply 100~240 Vac/dc

**N20K48 - 24V:** Model with power supply 12~24 Vdc / 24 Vac

## 9.2 CERTIFICATIONS

### CE Mark / UKCA

This is a Class A product. In a domestic environment, this product may cause radio interference in which case the user may be required to take adequate measures.

### ANATEL

This device is homologated by ANATEL, according to the regulated procedures for conformity assessment of telecommunications products, and meets the technical requirements applied.

This equipment is not subject to the protection from harmful interference and may not cause interference with duly authorized systems.

For more information, see the ANATEL website [www.anatel.gov.br](http://www.anatel.gov.br).

### FCC

This equipment has been tested and found to comply with the limits for a Class A digital device, pursuant to Part 15 of the FCC Rules. These limits are designed to provide reasonable protection against harmful interference when the equipment is operated in a commercial environment. This equipment generates, uses, and can radiate radio frequency energy and, if not installed and used in accordance with the instruction manual, may cause harmful interference to radio communications.

Any changes or modifications not expressly approved by the party responsible for compliance could void the user's authority to operate this equipment.

**RF Exposure:** A distance of 20 cm shall be maintained between the antenna and users, and the transmitter module may not be co-located with any other transmitter or antenna.

This device complies with part 15 of the FCC Rules. Operation is subject to the following two conditions: (1) This device may not cause harmful interference, and (2) this device must accept any interference received, including interference that may cause undesired operation.



## 10 WARRANTY

Warranty conditions are available on our website [www.novusautomation.com/warranty](http://www.novusautomation.com/warranty).