



# N1050 Controller

## TEMPERATURE CONTROLLER – INSTRUCTIONS MANUAL – V1.0x M

### SAFETY ALERTS

The symbols below are used on the equipment and throughout this document to draw the user's attention to important operational and safety information.

<b>CAUTION:</b> Read the manual thoroughly before installing and operating the equipment.	<b>CAUTION OR DANGER:</b> Electrical shock hazard.

All safety related instructions that appear in the manual must be observed to ensure personal safety and to prevent damage to either the instrument or the system. If the instrument is used in a manner not specified by the manufacturer, the protection provided by the equipment may be impaired.

### INSTALLATION / CONNECTIONS

The controller must be fastened on a panel, following the sequence of steps described below:

- Prepare a panel cut-out according to specifications.
- Remove the mounting clamps from the controller.
- Insert the controller into the panel cut-out.
- Slide the mounting clamp from the rear to a firm grip at the panel.

### ELECTRICAL CONNECTIONS

The layout of the features on the back panel of the controller is shown in **Fig. 01**:

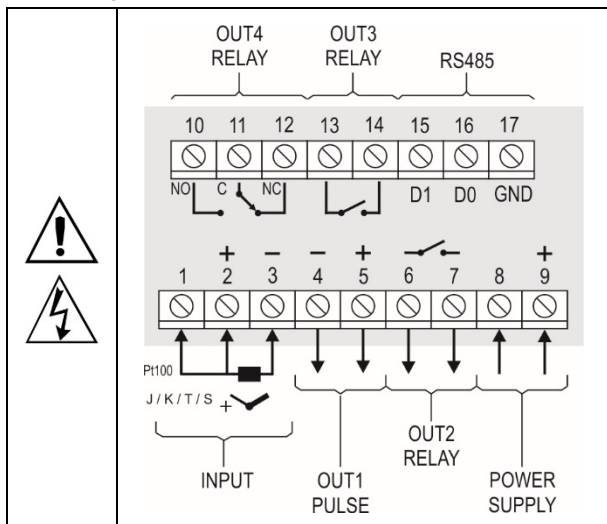

**Fig. 01** - Inputs, outputs and power supply connections

### RECOMMENDATIONS FOR THE INSTALLATION

- All electrical connections are made to the screw terminals at the rear of the controller.
- To minimize the pick-up of electrical noise, the low voltage DC connections and the sensor input wiring should be routed away from high-current power conductors. If this is impractical, use shielded cables. In general, keep cable lengths to a minimum.
- All electronic instruments must be powered by a clean mains supply, proper for instrumentation.
- It is strongly recommended to apply RC'S FILTERS (noise suppressor) to contactor coils, solenoids, etc. In any application it is essential to consider what can happen when any part of the system fails. The controller features by themselves cannot assure total protection

### FEATURES

#### INPUT TYPE SELECTION

The input type to be used by the controller is defined in the device configuration. **Table 01** shows the available input options. One of these must be selected during device configuration.

TYPE	CODE	RANGE OF MEASUREMENT
Thermocouple J	tc J	Range: -110 to 950 °C (-166 to 1742 °F)
Thermocouple K	tc K	Range: -150 to 1370 °C (-238 to 2498 °F)
Thermocouple T	tc t	Range: -160 to 400 °C (-256 to 752 °F)
Thermocouple S	tc S	Range: -50 to 1760 °C (-58 to 3200 °F)
Pt100	Pt	Range: -200 to 850 °C (-328 to 1562 °F)

**Table 01** - Input types

#### OUTPUTS

The controller offers two, three or four output channels, depending on the loaded optional features. The output channels are user configurable as **Control Output**, **Alarm 1 Output**, **Alarm 2 Output**, **Alarm 1 or Alarm 2 Output** and **LBD (Loop Break Detect) Output**.

- OUT1** Pulse type output of electrical voltage. 5 Vdc / 50 mA max. Available on terminals 4 and 5.
- OUT2** Relay SPST-NA. Available on terminals 6 and 7.
- OUT3** Relay SPST-NA. Available on terminals 13 and 14.
- OUT4** Relay SPDT. Available on terminals 10, 11 and 12.

#### CONTROL MODE

The controller can operate in two different manners: Automatic mode or Manual mode. In automatic mode (**Auto**) the controller defines the amount of power to be applied on the **process**, based on the set parameters (SP, PID, etc.). In the manual mode (**MAN**) the user defines this value. The parameter **Ctrl** defines the control mode to be adopted.

**PID AUTOMATIC MODE**

For the Automatic mode, there are two different strategies of control: PID control and ON/OFF control.

PID control has its action based on a control algorithm that takes into account the deviation of PV with respect to SP and based on the **Pb**, **ir** and **dt** parameters.

On the other hand, the ON/OFF control (obtained when  $Pb=0$ ) operates with 0 % or 100 % of power, when PV deviates from SP.

The determination of the PID parameters (**Pb**, **ir** and **dt**) is described in the item DETERMINATION OF PID PARAMETERS of this manual.

**CONTROL OUTPUT**

The control strategy can operated in **ON/OFF** mode or **PID** mode. To operate in **ON/OFF** mode, the value set in **Pb** parameter must be **0.0**. The values for the PID parameters can be automatically determined enabling the auto-tuning function (**Autun**).

**ALARM OUTPUT**

The controller contains 2 alarms that can be directed (assigned) to any output channel. These alarms can be configured to operate in different functions, as described in **Table 02**.

<b>oFF</b>	Alarm off.	
<b>Lo</b>	Alarm of Absolute Minimum Value. Triggers when the value of measured <b>PV</b> is <b>below</b> the value defined for alarm <i>Setpoint</i> (SP1 or SPA2).	
<b>Hi</b>	Alarm of Absolute Maximum Value. Triggers when the value of measured <b>PV</b> is <b>above</b> the value defined for alarm <i>Setpoint</i> .	
<b>dIF</b>	Alarm of Differential Value. In this function, the parameters <b>SP.A1</b> and <b>SP.A2</b> represent the deviation of PV in relation to the SP of CONTROL.	
<b>dIF.L</b>	Alarm of Minimum Differential Value. It triggers when the value of PV is <b>below</b> the point set by SP-SPA1 (using the Alarm 1 as an example).	
<b>dIF.H</b>	Alarm of Valor Maximum Differential Value. Triggers when the value of PV is <b>above</b> the defined point by SP+SPA1 (using Alarm 1 as example).	
<b>iErr</b>	Alarms of the Sensor Break (Sensor <i>Break Alarm</i> ). It is activated when the Input presents problems such as interrupted sensor, bad connection, etc.	
<b>rS</b>	Event (ramp and Soak). Triggered in a specific program segment.	

**Table 02** – Alarm functions

**Note 1:** The figures are also valid for Alarm 2 (**SP.A2**).

**Note 2:** Alarms configured with the **Hi**, **dIF**, and **dIF.H** functions also trigger their associated output when a sensor fault is identified and signaled by the controller. A relay output, for example, configured to act as a High Alarm (**Hi**), will operate when the SPAL value is exceeded and also when the sensor connected to the controller input is broken.

**INITIAL BLOCKING OF ALARM**

The **Initial Blocking** option inhibits the alarm from being recognized if an alarm condition is present when the controller is first energized. The alarm will be enabled only after the occurrence of a non-alarm condition followed by a new occurrence for the alarm.

The Initial Blocking is useful, for instance, when one of the alarms is configured as a minimum value alarm, causing the activation of the alarm soon upon the process start-up, an occurrence that may be undesirable.

The Initial Blocking is disabled for the sensor break alarm function **iErr**.

**RUN FUNCTION**

The **RUN** function allows the user to enable and disable the device operation. It works like a general key.

When in the on condition (**RUN=YES**), the controller is enabled to operate and the control outputs and the alarm are acting normally.

When in the off condition (**RUN=No**), the controller does not acts on the process, summarily switching off its outputs. No function is performed and only the measured temperature indication remains operative.

Function available in the **RUN** parameter in the controller Operation cycle. The **RUN** indicator on the frontal panel of the controller turns on when the control is enabled (**RUN=YES**).

**SAFE OUTPUT VALUE WITH SENSOR FAILURE**

Function that ensures that the control output is in a safe condition for the process when an error in the sensor input is identified.

When a fault is identified in the sensor, the controller will determine the percentage value set in the parameter **iE.oU** for the control output. The controller will remain in this condition until the sensor failure disappears. When in ON/OFF mode, the values for **iE.oU** are only 0 and 100%. With control in PID mode, any value between 0 and 100% will be accepted.

**LBD FUNCTION – LOOP BREAK DETECTION**

The parameter **LbdE** defines a time interval, in minutes, within which the PV is expect to react to a control output signal. If the PV does not react properly within the time interval configured, the controller will signal the occurrence of the LBD event, which indicates control loop problems, in its display.

A LBD event may be sent to any output channel. To do so, just configure the desired output channel with the **Lbd** function which, in this event, will be triggered.

The LDB function is disabled when the parameter is programmed with 0 (zero).

This function is useful in detecting system failures, such us defective sensors or actuators, loads and power supply, among others.

**OFFSET**

This feature allows a small adjustment to the PV indication. Also allows you to correct measurement errors that appear, for example, during the replacement of a temperature sensor.

**TIMERS**

The controller has two timers (T1 and T2), which operate independently of the temperature control actuation.

The parameters that define the operation mode of these timers are presented in the Timer Cycle.

The time count always starts with T1 and, at the end of it, starts the T2 count.

The time base can be set as HH:MM or MM:SS in the parameter **E.Eb**.

Any of the controller outputs can be linked to the timers.

The special parameter (**E.RUN**) allows disabling the temperature controller at the end of the timer.

The A3 and A4 indicators on the front of the controller are linked to the conditions of the T1 and T2 timers, respectively.

**TIMER T1**

T1 is the main timer. Its operating mode is set with the configuration of two parameters:

- E.Stt** Timer trigger.
- E.End** Behavior of the output timer.

**Note 3:** The T1 adjustment parameter can also be shown in the Operation Cycle of the controller by parameter **E.1.E**.

**TIMER T1 TRIGGER**

There are three Timer T1 trigger options, available in parameter **E.Stt**:

<b>E.Stt</b> <i>Timer Start</i>	<b>oFF</b>	Defines the start mode of the <b>T1</b> timer. Timer off (T1 and T2). The other parameters related to the timer will not be displayed.
	<b>SP</b>	Starts the time count when the measured temperature (PV) value reaches the SP temperature value set for the process.
	<b>F</b>	Starts the time count via the <b>F</b> key. Once started, the timer will stop if the <b>F</b> key is pressed with a new short touch (1 s). A new short touch will resume the timer. A long touch (3 s) on the <b>F</b> key will immediately end the timer cycle in progress. <b>Note 4:</b> The timer trigger via the <b>F</b> key is linked to the control condition enabled ( <b>RUN=YES</b> ).
	<b>RUN</b>	Starts the time count when the control is enabled ( <b>RUN=YES</b> ).

**Note 5:** The timer trigger via the **F** key is linked to the control condition enabled (**RUN=YES**).

**Note 6:** In the **E.Stt** parameter, the **oFF** option disables the T1 and T2 timers and hides all parameters related to this feature.

**BEHAVIOR OF OUTPUT T1 DURING T1**

The T1 output has two different behavior possibilities during T1 timer. The parameter **E.End** allows its definition.

The **A3** indicator on the controller frontal indicates the timer current step.

<b>E.End</b> <i>Timer End</i>	<b>on</b>	Behavior of output <b>T1</b> at the end of the T1 timer. T1 output turns on at the end of T1. When starting the T1 timer, the T1 output remains off. At the end of the timer, output T1 is turned on and will remain on until a new cycle starts. The A3 indicator flashes during the T1 timer. After T1, it is permanently On, indicating that the output still on (see <b>Note 7</b> ).
	<b>oFF</b>	T1 output turns off at the end of T1. In this mode, the T1 output turns on at the start of the T1 timer and turns off at the end of the T1 timer. The A3 indicator flashes during the T1 timer and turns off at the end of T1 (see <b>Note 7</b> ).

**Note 7:** When the timer is interrupted by pressing the **F** key, the indicator (A3 or A4) will flash quickly.

**BEHAVIOR OF TEMPERATURE CONTROL AT THE END OF THE TIMER**

During the timing of T1 and T2 intervals, the temperature control acts according to its configuration and in an independent way. However, at the end of the T1 + T2 interval, it is possible to set the controller to disabled the temperature control, changing the condition of the parameter RUN to NO. In the Timer Cycle of the controller, the parameter **E.RUN** allows you to create the desired configuration:

<b>E.RUN</b> <i>Timer Run</i>	Temperature control behavior at the end of the <b>T1 + T2</b> timers.
	<ul style="list-style-type: none"> <li><b>on</b> Temperature control continues to operate.</li> <li><b>oFF</b> Ends the control at the end of the timer (<b>RUN=No</b>) (see <b>Note 5</b>).</li> </ul>

**TIMER T2**

T2 is the secondary timer. T2 always start its timer at the end of T1. T2 can also be linked to any available output of the controller. The linked output always turns on at the beginning of T1 and turns off at its end.

The A4 indicator shows the timer T2 condition:

- T2 in progress = A4 is flashing.
- T2 do not start or is already finished = A4 is off.

**TIMER DIRECTION**

For both timers, time counting can be set in ascending or descending mode. In UP mode, the countdown starts at zero and goes up to the value of the programmed time interval (T1 T2). In the DOWN mode, the countdown starts at the programmed time interval value and goes down to zero. The timer direction is defined in parameter **E.d ir**.

<b>E.d ir</b> <i>Timer Direction</i>	T1 timing direction.
	<ul style="list-style-type: none"> <li><b>uP</b> Continuous counting, starting at zero.</li> <li><b>dn</b> Countdown.</li> </ul>

**TIMERS TIME BASE**

The parameter **E.Eb** in the Timer Cycle set the time base to be used. The options are:

- HH: MM** The T1 and T2 time intervals are displayed in hours and minutes.
- MM: SS** The T1 and T2 time intervals are displayed in minutes and seconds.

**USB INTERFACE**

The USB interface is used to CONFIGURE, MONITOR or UPDATE the controller FIRMWARE. The user should use **QuickTune** software, which offers features to create, view, save and open settings from the device or files on the computer. The tool for saving and opening configurations in files allows the user to transfer settings between devices and perform backup copies.

For specific models, **QuickTune** allows to update the firmware (internal software) of the controller via the USB interface.

For MONITORING purposes, the user can use any supervisory software (SCADA) or laboratory software that supports the MODBUS RTU communication over a serial communication port. When connected to a computer's USB, the controller is recognized as a conventional serial port (COM x).



The user must use **QuickTune** software or consult the DEVICE MANAGER on the Windows Control Panel to identify the COM port assigned to the controller.

The user should consult the mapping of the MODBUS memory in the controller's communication manual and the documentation of the supervision software to start the MONITORING process.

Follow the procedure below to use the USB communication of the device:

1. Download **QuickTune** software from our website and install it on the computer. The USB drivers necessary for operating the communication will be installed with the software.

2. Connect the USB cable between the device and the computer. The controller does not have to be connected to a power supply. The USB will provide enough power to operate the communication (other device functions may not operate).
3. Run the **QuickTune** software, configure the communication and start the device recognition.

The USB interface IS NOT SEPARATE from the signal input (PV) or the controller's digital inputs and outputs. It is intended for temporary use during CONFIGURATION and MONITORING periods. For the safety of people and equipment, it must only be used when the piece of equipment is completely disconnected from the input/output signals. Using the USB in any other type of connection is possible but requires a careful analysis by the person responsible for installing it. When MONITORING for long periods of time and with connected inputs and outputs, we recommend using the RS485 interface, which is available or optional in most of our products.

## OPERATION

The front panel of the controller is shown in the **Fig. 02**:



**Fig. 02** - Identification of the parts referring to the front panel

**Display:** Displays the measured variable, symbols of the configuration parameters and their respective values/conditions.

**Tx/RX Indicators:** Flashes when the controller exchanges data with the RS-485 communication network.

**AT Indicator:** On while the controller is in automatic tuning.

**MAN Indicator:** On while the controller is in manual mode.

**RUN Indicator:** On with control enabled (**RUN=YES**). When flashing, it indicates that a program has stopped running.

**OUT Indicator:** Indicates the instantaneous state of the control output(s).

**A1 and A2 Indicators:** Indicate the occurrence of an alarm condition.

**A3 Indicator:** It signals the condition of timer T1.

**A4 Indicator:** It signals the condition of timer T2.

**°C / °F Indicators:** Identify the set temperature unit.

**P Key:** Key used to advance to successive parameters and parameter cycles.

**▲ Increment Key and ▼ Decrement Key:** Keys used to change the parameter values.

**◻ Key:** Keys used to retrocede parameters when in configuration mode and performs special functions.

## INITIALIZATION

When the controller is energized, the number of its current software version will be displayed in the first 3 seconds, and then the value of the measured process variable (temperature) will be displayed on the upper display. The value of SP is displayed in the lower display. This is the **Display Screen**.

To be used in a process, the controller needs to be preconfigured. The configuration consists of the definition of each of the several parameters presented. The user must understand the importance of

each parameter and, for each one, determine a valid condition or a valid value.

The configuration parameters are gathered into groups of affinities, called parameter cycles. The 7 parameter cycles are:

- 1 – Operation / 2 – Tuning / 3 – Programs / 4 – Alarms /
- 5 – Input / 6 – Timer / 7 – Calibration

The **P** key gives access to the cycles and their parameters:

When you hold the **P** key down, the controller will cycle from one cycle to another every 2 seconds, displaying the first parameter of each cycle:

**PV >> RUN >> Pr.Eb >> Fu.R1 >> TYPE >> PRSS >> PV ...**

To enter the desired cycle, simply release the **P** key when your first parameter is displayed. To advance on the parameters of this cycle, use the **P** key with short beeps. To return parameters, use the **◻** key.

Each parameter has its symbol displayed in the upper display. Its respective value/condition is shown in the lower display.

Depending on the Configuration Protection adopted, the **PRSS** parameter is displayed as the first parameter of the cycle where the protection starts (See chapter CONFIGURATION PROTECTION).

## DESCRIPTION OF THE PARAMETERS

### OPERATION CYCLE

<b>PV + SP</b>	<b>PV Indication screen.</b> On the higher display (white) the value of the measured variable (PV) temperature is shown. On the lower display (green), the control setpoint (SP) is shown.
<b>PV + TM</b>	<b>PV Indication Screen and T1 Count.</b> The upper display (white) shows the value of the measured temperature (PV).
<b>T 1</b> <i>Timer 1</i>	<b>T1 time interval adjustment.</b> From 00:00 to 99:59 (HH:MM or MM:SS) Parameter displayed in this cycle when set in parameter <b>T 1.E</b> .
<b>[E r]</b> <i>Control</i>	<b>Control Mode:</b> <b>RuLo</b> It means automatic control mode. <b>MAN</b> It means manual control mode. (Bumpless transfer between automatic and manual control modes).
<b>PV / MV</b>	<b>MV screen.</b> Displays the PV value in the upper display and, in the lower display, displays the MV value, in percentage, applied to the control output. In Automatic Control mode, the value of MV can only be displayed. In Manual Control mode, the value of MV can be changed by the user. To differentiate this screen from the PV+SP screen, the value of MV blinks constantly.
<b>SP.R1</b> <b>SP.R2</b> <i>Setpoint Alarm</i>	<b>Alarm SP.</b> Value that defines the alarm activation point. For the alarms set up with the functions of the type <b>Differential</b> , these parameters define the deviations. For the alarm function <b>.Err</b> , this parameter is not used. Parameters shown in this cycle only when enabled in the parameters <b>SP 1.E</b> and <b>SP2.E</b> .

<b>PRG</b> <i>Program</i>	Allows you to select the ramp and soak program to be performed. <b>NONE</b> The controller does not perform any program. <b>1 to 5</b> Number of the program to be performed. With enabled outputs ( <b>RUN=YES</b> ), the selected program will be performed immediately.
<b>P.SEG</b> <i>Program Segment</i>	Screen for indication only. When a ramp and soak program is active, this parameter shows the number of the segment under execution, from 1 to 4.
<b>t.SEG</b> <i>Time Segment</i>	Screen for indication only. When a ramp and soak program is in execution, it shows the remaining time to the end of the current segment, in units of time configured in the <b>Pr.tb</b> parameter.
<b>RUN</b> <i>Run</i>	RUN function. Enables control outputs and alarms. <b>YES</b> Control enabled. <b>No</b> Control not enabled.

**TUNING CYCLE**

<b>Autun</b> <i>Auto Tune</i>	<b>Auto-tuning.</b> Enables the auto-tuning function for the PID parameters ( <b>Pb</b> , <b>ir</b> , <b>dt</b> ). See the chapter DETERMINATION OF PID PARAMETERS of this manual. <b>oFF</b> Auto-tuning is off. <b>FAST</b> Running auto-tuning in fast mode. <b>FuLL</b> Running auto-tuning in full mode.
<b>Pb</b> <i>Proportional Band</i>	<b>Proportional Band.</b> Value of the term <b>P</b> of the control mode PID, in percentage of the maximum span of the input type. Adjustable between 0 and 500.0 %. <b>When set to 0,0 (zero), control action is ON/OFF.</b>
<b>HYS</b> <i>Hysteresis</i>	<b>Control Hysteresis.</b> Hysteresis value for ON/OFF control. Adjustable between <b>0</b> and the width of the measuring range of the selected input type. Displayed only if proportional band = 0.
<b>ir</b> <i>Integral Rate</i>	<b>Integral Rate.</b> Value of the term <b>I</b> of the PID algorithm, in repetitions per minute (Reset). Adjustable between 0 and 24.00. Displayed only if proportional band ≠ 0.
<b>dt</b> <i>Derivative Time</i>	<b>Derivative Time.</b> Value of the term <b>D</b> of the control mode PID, in seconds. Adjustable between 0 and 250.0 seconds. Displayed only if proportional band ≠ 0.
<b>CT</b> <i>Cycle Time</i>	<b>Cycle Time.</b> Pulse Width Modulation (PWM) period in seconds. Adjustable between 0.5 and 100.0 seconds. With the use of contactors, the recommended value for the cycle time parameter must be greater than 10 s. Displayed only if proportional band ≠ 0.
<b>Act</b> <i>Action</i>	Action Control: <b>rE</b> Control with <b>Reverse Action</b> . Appropriate for <b>heating</b> . Turns control output on when PV is below SP. <b>d ir</b> Control with <b>Direct Action</b> . Appropriate for <b>cooling</b> . Turns control output on when PV is above SP.
<b>SF.S</b> <i>SoftStart</i>	<b>SoftStart Function.</b> Time interval, in seconds, while the controller limits the control output (MV) rising rate. Zero value disables the SoftStart function.

<b>out 1</b> <b>out 2</b> <b>out 3</b> <b>out 4</b> <i>Output</i>	Assign functions to the Output channels OUT1, OUT2, OUT3 and OUT4: <b>oFF</b> Not used. <b>Ctrl</b> Control output. <b>R 1</b> Alarm 1 output. <b>R 2</b> Alarm 2 output. <b>R 1,R 2</b> Alarm 1 + Alarm2. <b>t 1</b> T1 output. <b>t 2</b> T2 output. <b>Lbd</b> Loop Break Detect Alarm.
---	--

**PROGRAM CYCLE**

<b>Pr.tb</b> <i>Program time base</i>	Defines the time base that will be used by all Ramp and Soak programs. <b>HH:MM</b> Time base in hour:minute. <b>MM:SS</b> Time base in minute:second.
<b>Pr R</b> <i>Program restore</i>	<b>Program Restore.</b> Parameter that defines the behavior of the controller when it resumes from a power failure in the middle of a program execution of ramps and soaks. <b>ProG</b> Returns at the beginning of the program. <b>P.SEG</b> Returns the beginning of the segment. <b>t.SEG</b> Returns at the exact point where it stopped. <b>oFF</b> Returns with control disabled ( <b>RUN=No</b> ).
<b>Pr n</b> <i>Program number</i>	Selects the ramp and soak profile program to be edited/viewed. The sequence of parameters that follows refer to this selected program. Total of 5 programs possible (1 – 5).
<b>P.tol</b> <i>Program tolerance</i>	Maximum admitted deviation of PV with respect to SP. If exceeded, the program execution is suspended (the internal timer freezes) until the PV value is within the permissible deviation range. The value 0 (zero) disables the function.
<b>P.SP0</b> <b>P.SP4</b> <i>Program SP</i>	Program SP's. 0 to 4. Sets of 5 SP values that define the program profile of ramps and soaks.
<b>P.t 1</b> <b>P.t 4</b> <i>Program time</i>	Program segment time. 1 to 4. Sets the duration time, in seconds or minutes, of each of the 4 segments of the program being edited.
<b>P.E 1</b> <b>P.E 4</b> <i>Program Event</i>	Program segment alarm (alarms of event). Parameters that define which alarms are to be activated during the execution of a certain program segment: <b>oFF</b> Do not trigger an alarm on this segment. <b>R 1</b> Activate alarm 1 when program reaches this segment. <b>R 2</b> Activate alarm 2 when program reaches this segment. <b>R 1,R 2</b> Activate alarms 1 and 2 when program reaches this segment. The alarms chosen must have its function configured as <b>rS</b> .
<b>LP</b> <i>Link Program</i>	<b>Link Program.</b> At the end of running a program, any other program can have its execution started immediately. <b>0</b> Do not connect to any other program. <b>1 to 5</b> Program number to be connected.

**ALARMS CYCLE**

<b>Fu.A1</b> <b>Fu.A2</b> <i>Function Alarm</i>	<b>Functions of Alarms.</b> Defines the functions for the alarms among the options of the <b>Table 02</b> .
<b>SP.A1</b> <b>SP.A2</b> <i>Setpoint Alarm</i>	<b>Alarm SP.</b> Value that defines the point of actuation of the alarm outputs. For alarms programmed with <b>Differential</b> functions, these parameters define deviations.  This parameter is not used for the alarm function <b>OFF</b> , <b>Err</b> or <b>rS</b> .
<b>SP1.E</b> <b>SP2.E</b> <i>Setpoint Enable</i>	Configures display of SPA1 and SPA2 also in the Operation Cycle.  <b>YES</b> SPA1/SPA2 are displayed in the Operation Cycle.  <b>No</b> SPA1/SPA2 are NOT displayed in the Operation Cycle.  This parameter is not used for the alarm function <b>OFF</b> , <b>Err</b> or <b>rS</b> .
<b>bl.A1</b> <b>bl.A2</b> <i>Blocking Alarm</i>	Initial blocking alarms.  <b>YES</b> Enables initial blocking.  <b>No</b> Inhibits initial blocking.  This parameter is not used for the alarm function <b>OFF</b> .
<b>HY.A1</b> <b>HY.A2</b> <i>Hysteresis of Alarm</i>	<b>Hysteresis of Alarm.</b> Defines the difference between the value of PV at which the alarm is triggered and the value at which it is turned off.  This parameter is not used for the alarm function <b>OFF</b> , <b>Err</b> or <b>rS</b> .
<b>FLSH</b> <i>Flash</i>	Allows visual signalization of an alarm occurrence by flashing the indication of PV in the operation level.  <b>YES</b> Enables alarm signaling flashing PV.  <b>No</b> Disables alarm signaling flashing PV.  This parameter is not used for the alarm function <b>OFF</b> .

**INPUT CYCLE**

<b>TYPE</b> <i>Type</i>	<b>Input Type.</b> Selects the input signal type to be connected to the process variable input. Refer to <b>Table 01</b> for the available options.  (J): <b>Ec J</b> - 110 to 950 °C / -166 to 1742 °F (K): <b>Ec K</b> - 150 to 1370 °C / -238 to 2498 °F (T): <b>Ec T</b> - 160 to 400 °C / -256 to 752 °F (S): <b>Ec S</b> - 50 to 1760 °C / -58 to 3200 °F (Pt100): <b>Pt</b> - 200 to 850 °C / -328 to 1562 °F
<b>FLtr</b> <i>Filter</i>	<b>Digital Input Filter.</b> Used to improve the stability of the measured signal (PV). The set value corresponds to the value of the time constant. In seconds (s). Adjustable from 0 to 300 s.
<b>dP.Po</b> <i>Decimal Point</i>	Selects the decimal point position to be viewed.
<b>un, t</b> <i>Unit</i>	Selects display indication for degrees Celsius or Fahrenheit:  <b>C</b> Indication in Celsius.  <b>F</b> Indication in Fahrenheit.
<b>OFFS</b> <i>Offset</i>	Offset value to be added to the PV reading to compensate sensor error.
<b>SP.LL</b> <i>SP Low Limit</i>	Defines the lower limit for adjustment of SP.

<b>SP.HL</b> <i>SP High Limit</i>	Defines the upper limit for adjustment of SP.
<b>LbdT</b> <i>Loop break detection time</i>	Time interval for the LBD function. Defines the maximum interval of time for the PV to react to a control command. In minutes.
<b>IE.Ou</b> <i>Input Error Output</i>	Percentage value to be applied to the output on any failure of the sensor that is connected to the controller input.
<b>BAud</b> <i>Baud Rate</i>	Baud rate of serial communication. Available in the following baud rates (in kbps):  1.2, 2.4, 4.8, 9.6, 19.2, 38.4, 57.6 and 115.2
<b>PrEtY</b> <i>Parity</i>	Parity of the serial communication.  <b>NONE</b> Without parity.  <b>EVEN</b> Even parity.  <b>odd</b> Odd parity.
<b>Addr</b> <i>Address</i>	Number between 1 and 247 that identifies the controller in the serial communication network.

**TIMER CYCLE**

<b>T.Stt</b> <i>Timer Start</i>	Sets the start mode of the <b>T1</b> timer.  <b>OFF</b> Timers off ( <b>Note 8</b> ).  <b>SP</b> Starts when PV reaches SP.  <b>F</b>  key starts, stops, and restarts the timer (see <b>Note 8</b> ).  <b>RUN</b> Starts when enabling the control ( <b>RUN=YES</b> ).
<b>T.dir</b> <i>Timer Direction</i>	Count direction of <b>T1</b> timer.  <b>UP</b> Continuous counting, starting at zero.  <b>dn</b> Countdown.
<b>T.tb</b> <i>Timer time base</i>	<b>Timer time base.</b> Sets the time base adopted for the timer.  <b>HH:MM</b> Time base in seconds.  <b>MM:SS</b> Time base in minutes.
<b>T1</b> <i>Timer 1</i>	<b>T1</b> time interval adjustment. From 00:00 to 99:59 (HH:MM or MM:SS).
<b>T1.E</b> <i>Timer Enable</i>	Displays the "T1 time interval adjustment" ( <b>T1</b> ) also in the Operation Cycle.  <b>YES</b> Release T1 for the Operation Cycle.  <b>No</b> It does not release T1 for the Operation Cycle.
<b>T.End</b> <i>Timer End</i>	T1 output behavior at the end of the T1 timer.  <b>on</b> T1 output <b>turns on</b> at the end of T1.  <b>OFF</b> T1 output <b>turns off</b> at the end of T1.
<b>T2</b> <i>Timer 2</i>	<b>T2</b> time interval adjustment. From 00:00 to 99:59 (HH:MM or MM:SS). Time interval where <b>T2</b> output remains on after the end of the T1 timer.
<b>T.RUN</b> <i>Timer RUN</i>	Temperature control behavior at the end of <b>T1 + T2</b> timers.  <b>on</b> Temperature control continues to operate.  <b>OFF</b> Temperature control is disabled at the end of the timer ( <b>RUN=No</b> ).

**Note 8:** In the **T.Stt** parameter, the **OFF** option disables completely the T1 and T2 timers and hides all parameters related to this function.

**CALIBRATION CYCLE**

All types of input are calibrated in the factory. In case a recalibration is required. It shall be carried out by a specialized professional. In case this cycle is accidentally accessed, do not perform alteration in its parameters.

<b>PASS</b> <i>Password</i>	Access password input. This parameter is presented before the protected cycles (See chapter CONFIGURATION PROTECTION).
<b>CALb</b> <i>Calibration</i>	Enables the possibility for calibration of the indicator. When the calibration is not enabled, the related parameters are hidden.
<b>in.LC</b> <i>Input Low Calibration</i>	Enter the value corresponding to the low scale signal applied to the analog input.
<b>in.HC</b> <i>Input High Calibration</i>	Enter the value corresponding to the full scale signal applied to the analog input.
<b>REST</b> <i>Restore</i>	Restores the factory calibration for all inputs and outputs, disregarding modifications carried out by the user.
<b>CJ</b> <i>Cold Junction</i>	This screen is for information purpose only. This parameter is not used for the input function type <b>PE</b> .
<b>PAS.C</b> <i>Password Change</i>	Allows defining a new access password, always different from zero.
<b>Prot</b> <i>Protection</i>	Sets up the level of protection. See <b>Table 03</b> .
<b>H.Prg</b> <i>Hold Program</i>	Enables the <b>Hold Program</b> function on the  key.
<b>Ctrl.E</b> <i>Run Enable</i>	Enables the display of the Control parameter in the Operation Cycle ( <b>Ctrl</b> ) of the controller. In this parameter, the user sets the operation mode of the controller.  <b>Auto</b> Automatic control mode. <b>MAN</b> Manual control mode.
<b>PRG.E</b> <i>Run Enable</i>	Enables the display of the Run Program ( <b>E.Prg</b> ) in the Operation Cycle of the controller.
<b>RUN.E</b> <i>Run Enable</i>	Enables the display of the RUN parameter on the controller operating cycle.
<b>SnH</b> <i>Serial Number High</i>	Displays the first four digits of the electronic serial number of the controller.
<b>SnL</b> <i>Serial Number Low</i>	Displays the last four digits of the electronic serial number of the controller.

**CONFIGURATION PROTECTION**

The controller allows the protection of the configuration created by the user, avoiding improper manipulation.

The parameter **Protection (Prot)**, in the Calibration Cycle, determines the protection level to be used, limiting the access to particular cycles, as shown in **Table 03**.

PROTECTION LEVEL	PROTECTED CYCLES
1	Only the Calibration Cycle is protected.
2	Timer and Calibration Cycle are protected.
3	Input and Calibration Cycles are protected.
4	Alarms, Input, Timer, and Calibration Cycles are protected.

5	Programs, Alarms, Input, and Calibration Cycler are protected.
6	Tuning, Programs, Alarms, Input, Timer, and Calibration Cycler are protected.
7	All cycles, except SP screen in Operation Cycle, are protected.
8	All cycles, including SP, are protected.

**Table 03** – Levels of Protection for the Configuration

**ACCESS PASSWORD**

The protected levels, when accessed, request the user to provide the **Access Password** for granting permission to change the configuration of the parameters on these levels.

The prompt **PASS** precedes the parameters on the protected levels. If no password is entered, the parameters of the protected levels can only be visualized.

The Access Password is defined by the user in the parameter **Password Change (PAS.C)**, present in the Calibration Cycle.

**The factory default for the password code is 1111.**

**PROTECTION ACCESS PASSWORD**

The protection system built into the controller blocks for 10 minutes the access to protected parameters after 5 consecutive frustrated attempts of guessing the correct password.

**MASTER PASSWORD**

The Master Password is intended for allowing the user to define a new password in the event of it being forgotten. The Master Password doesn't grant access to all parameters, only to the **Password Change** parameter (**PAS.C**). After defining the new password, the protected parameters may be accessed (and modified) using this new password.

The master password is made up by the last three digits of the serial number of the controller **added** to the number 9000.

As an example, for the equipment with serial number 07154321, the master password is 9321.

**RAMP AND SOAK PROGRAMS**

Characteristic that allows the elaboration of a behavior profile for the process. Each program consists of a set of up to **4 segments**, called RAMP AND SOAK PROGRAM, defined by SP values and time intervals.

Up to **5 different ramp and soak programs** can be created. The figure below displays a profile model:

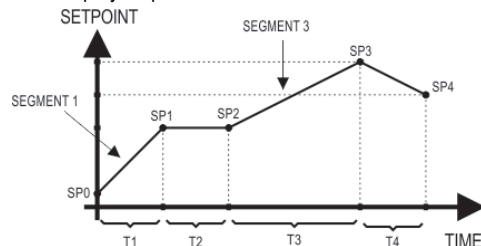

**Fig. 03** - Example of a Ramp and Soak program

Once the program is defined and executed, the controller automatically generates the SP according to the program.

To execute a program with a number of segments smaller than 4 (four), simply program 0 (zero) for the next segment time to the last desired segment.

The program tolerance function **P.LoL** defines the maximum deviation between PV and SP during program execution. If this deviation is exceeded, the time count is interrupted until the deviation is within the programmed tolerance (gives SP priority). If zero is set in the tolerance, the controller executes the defined program without considering any deviations between PV and SP (gives priority to time).

The configured **time limit** for each segment is 5999 and can be displayed in seconds or minutes, depending on the time base configured.

### RESTORE PROGRAM AFTER POWER FAILURE

Function that defines the behavior of the controller when it resumes from a power failure in the midst of a program execution of ramps and soaks. The restore options are:

- PROG** Returns at the beginning of the program.
- P.SEG** Returns the beginning of the segment.
- E.SEG** Returns to the point of the previous program segment the power failure (\*).
- OFF** Returns with control disabled (**RUN=No**).

(\*) In the option **Returns to the point of the previous program segment (E.SEG)**, you must consider uncertainties of up to 1 minute between the time of the segment at the moment of the power outage and the time of the segment adopted to resume the execution of the program at the moment of the power supply return.

The **E.SEG** option has its performance related to the configuration adopted by the parameter **P.LOL**. Thus, it also has the following functions:

- 1 With **P.LOL** set to zero, the controller resumes the execution of the program immediately after the energy return (from the point and segment where it stopped), regardless of the **PV** value at that time.
- 2 With **P.LOL** non-zero, the controller waits until **PV** enters the deviation range defined by the value of **P.LOL** and then resumes the program execution.

### LINK OF PROGRAMS

It is possible to create a large, more complex program with up to 20 segments connecting the 5 programs. Thus, at the end of the execution of a program, the controller immediately starts executing another program.

In the elaboration of a program it was defined in the screen **LP** whether or not there will be connection to another program.

In order for the controller to be able to run a certain program or programs continuously, simply connect a program to itself or the last program to the first one.

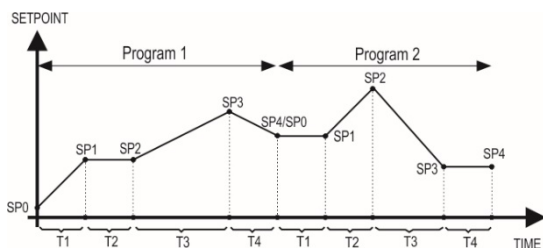

Fig. 04 – Example of linked programs

### EVENT ALARM

The Event Alarm function allows you to program the triggering of alarms in specific segments of a program.

For this function to operate, the alarms to be triggered must have their function set to **r5** and are configured in parameters **PE 1** to **PE4**.

### HOLD PROGRAM FUNCTION

This function stops program execution when the **STOP** key is pressed.

The **H.PRG** parameter of the Calibration Cycle enables the **STOP** key to perform this function.

Pressing the **STOP** key for **1 second** will immediately program the program. A new press, also of **1 second**, resumes its execution.

While the program is stopped, the **RUN** indicator on the controller frontal remains flashing.

## DETERMINATION OF PID PARAMETERS

During the process of determining automatically the PID parameters, the system is controlled in **ON/OFF** in the programmed Setpoint. The auto-tuning process may take several minutes to be completed, depending on the system. The steps for executing the PID auto-tuning are:

- Select the process Setpoint.
- Enable auto-tuning at the parameter **Autun**, selecting **FRSE** or **FULL**.

The option **FRSE** performs the tuning in the minimum possible time, while the option **FULL** gives priority to accuracy over the speed.

The sign **TUNE** remains lit during the whole tuning phase. The user must wait for the tuning to be completed before using the controller.

During auto tuning period the controller will impose oscillations to the process. **PV** will oscillate around the programmed set point and controller output will switch on and off many times.

If the tuning does not result in a satisfactory control, refer to **Table 04** for guidelines on how to correct the behavior of the process.

PARAMETER	VERIFIED PROBLEM	SOLUTION
Proportional Band	Slow answer	Decrease
	Great oscillation	Increase
Rate Integration	Slow answer	Increase
	Great oscillation	Decrease
Derivative Time	Slow answer or instability	Decrease
	Great oscillation	Increase

Table 04 - Guidance for manual adjustment of the PID parameters

For further details on PID tuning, visit our web site [www.novusautomation.com](http://www.novusautomation.com).

## MAINTENANCE

### PROBLEMS WITH THE CONTROLLER

Connection errors and inadequate programming are the most common errors found during the controller operation. A final revision may avoid loss of time and damages.

The controller displays some messages to help the user identify problems.

MESSAGE	DESCRIPTION OF THE PROBLEM
----	Open input. No sensor or signal.
<b>Err0</b>	Connection and/or configuration problems. Check the wiring and the configuration.

Other error messages may indicate hardware problems requiring maintenance service.

### INPUT CALIBRATION

All inputs are factory calibrated and recalibration should only be done by qualified personnel. If you are not familiar with these procedures do not attempt to calibrate this instrument.

The calibration steps are:

- a. Configure the input type to be calibrated in the **TYPE** parameter.
- b. Configure the lower and upper limits of indication for the maximum span of the selected input type.
- c. Go to the Calibration Cycle.
- d. Enter the access password.
- e. Enable calibration by setting **YES** in **CRLB** parameter.
- f. Using an electrical signals simulator, apply a signal a little higher than the **low** indication limit for the selected input.
- g. Access the parameter **in.LC**. With the keys **▲** and **▼** adjust the display reading such as to match the applied signal. Then press the **P** key.



- h. Apply a signal that corresponds to a value a little lower than the upper limit of indication.
- i. Access the parameter **in.HC**. With the keys **▲** and **▼** adjust the display reading such as to match the applied signal.
- j. Return to the Operation Cycle.
- k. Check the resulting accuracy. If not good enough, repeat the procedure.

**Note 9:** When checking the controller calibration with a Pt100 simulator, pay attention to the simulator minimum excitation current requirement, which may not be compatible with the 0.170 mA excitation current provided by the controller.

### SERIAL COMMUNICATION

The controller can be supplied with an asynchronous RS-485 digital communication interface for master-slave connection to a host computer (master).

The controller works as a slave only and all commands are started by the computer which sends a request to the slave address. The addressed unit sends back the requested reply.

The controller also accepts Broadcast commands.

### CHARACTERISTICS

- Signals compatible with RS-485 standard. MODBUS (RTU) Protocol. Two wire connection between 1 master and up to 31 (addressing up to 247 possible) instruments in bus topology. The communication signals are electrically insulated from the rest of the device.
- Maximum connection distance: 1000 meters.
- Time of disconnection for the controller: Maximum 2 ms after last byte.
- Selectable speed; 8 data bits; 1 stop bit; selectable parity (no parity, pair or odd).
- Time at the beginning of response transmission: maximum 100 ms after receiving the command.

The RS-485 signals are:

D1	D	D+	B	Bi-directional data line.	Terminal 15
D0	$\bar{D}$	D-	A	Bi-directional inverted data line.	Terminal 16
C		Optional connection that improves the performance of the communication.		Terminal 17	
GND					

### CONFIGURATION OF PARAMETERS FOR SERIAL COMMUNICATION

Three parameters must be configured for using the serial type:

**bRud** Communication speed.

**P-r-ty** Parity of the communication.

**Raddr** Communication address for the controller..

### REDUCED REGISTERS TABLE FOR SERIAL COMMUNICATION

#### COMMUNICATION PROTOCOL

The MOSBUS RTU slave is implemented. All configurable parameters can be accessed for reading or writing through the communication port. Broadcast commands are supported as well (address 0).

The available Modbus commands are:

03 - Read Holding Register                      06 - Write Single Register

05 - Write Single Coil                              16 - Write Multiple Register

The most commonly used registrars are listed below. For complete information, see the **Table of Registers for Serial Communication**, available in the **N1050** section of our website [www.novus.com.br](http://www.novus.com.br).

All registers are 16 bit signed integers.

ADDRESS	PARAMETER	REGISTER DESCRIPTION
0000	Active SP	Read: Active control SP (main SP, from ramp and soak or from remote SP). Write: to main SP. Range: from <b>SP.LL</b> to <b>SP.HL</b> .
0001	PV	Read: Process Variable. Write: Not allowed. Range: Minimum value is the one configured in <b>SP.LL</b> and the maximum value is the one configured in <b>SP.HL</b> . Decimal point position depends on <b>dP.Pa</b> value. In case of temperature reading, the value read is always multiplied by 10, independently of <b>dP.Pa</b> value.
0002	MV	Read: Output Power in automatic or manual mode. Write: Not allowed. See address 28. Range: 0 to 1000 (0.0 to 100.0 %).

### IDENTIFICATION

N1050	A	B	C
-------	---	---	---

**A:** Available Outputs:

**PR:** OUT1= Pulse / OUT2= Relay

**PRRR:** OUT1= Pulse / OUT2= OUT3= OUT4= Relay

**B:** Serial Communication:

**(Blank)** (basic version, without serial communication)

**485** (RS-485 serial version, Modbus protocol)

**C:** Power Supply:

**(Blank):** .....Model standard

..... 100-240 Vac / 48-240 Vdc; 50-60 Hz

**24 V:** ..... Model 24 V

..... 12-24 Vdc / 24 Vac

## SPECIFICATIONS

**DIMENSIONS:**..... 48 x 48 x 80 mm (1/16 DIN)  
 Cut out the panel: ..... 46 x 46 mm (+0.5 -0.0 mm)  
 Approximate Weight: ..... 75 g

### POWER SUPPLY:

Model Standard: ..... 100 to 240 Vac ( $\pm 10\%$ ), 50/60 Hz  
 ..... 48 to 240 Vdc ( $\pm 10\%$ )  
 Model 24 V: ..... 12 to 24 Vcc / 24 Vca ( $-10\%$  /  $+20\%$ )  
 Maximum Consumption:..... 6 VA

### ENVIRONMENTAL CONDITIONS:

Operation Temperature: ..... 0 to 50 °C  
 Relative Humidity:..... 80 % @ 30 °C  
 For temperatures above 30 °C, reduce 3 % for each °C.  
 Internal use; Category of installation II, Degree of pollution 2,  
 Altitude < 2000 meters.

### TIMER

Timer Ranges: ..... 00:00 to 99:59 (mm:ss)  
 ..... 00:00 to 99:59 (hh:mm)  
 Delay when turning on the device: .....200 ms  
 Accuracy: ..... 0.5% of the measured value

**OUTPUT RESPONSE TIME:** ..... 10 ms for relay output  
 .....0.3 ms for pulse output

### INPUT:..... J, K, T, S and Pt100 (according to Table 01)

Internal Resolution:..... 32767 levels (15 bits)  
 Resolution of Display:..... 12000 levels (from -1999 up to 9999)  
 Rate of input reading: .....up 10 per second (\*)  
 Accuracy: ..... Thermocouples J, K, T: 0.25 % of the *span*  $\pm 1$  °C  
 ..... Thermocouple S: 0.25 % of the *span*  $\pm 3$  °C  
 ..... Pt100: 0.2 % of the *span*  
 Input Impedance: .....Pt100 and thermocouples: > 10 M $\Omega$   
 Measurement of Pt100: ..... 3-wire type ( $\alpha=0,00385$ )  
 With compensation for cable length, excitation current of 0.170 mA.

(\*) Value adopted when the Digital Filter parameter is set to 0 (zero) value. For Digital Filter values other than 0, the Input Reading Rate value is 5 samples per second.

### OUTPUTS:

OUT1: .....Voltage pulse, 5 V / 50 mA max.  
 OUT2: .....Relay SPST; 1.5 A / 240 Vac / 30 Vdc  
 OUT3: .....Relay SPST; 1.5 A / 240 Vac / 30 Vdc  
 OUT4: .....Relay SPDT; 3 A / 240 Vac / 30 Vdc

**FRONT PANEL:** ..... IP65, Polycarbonate (PC) UL94 V-2

**HOUSING:**..... IP20, ABS+PC UL94 V-0

### SPECIFIC CONNECTIONS FOR TYPE PIN TERMINAL.

**DISPLAY:** LCD type, alphanumeric with 11 segments.

**PROGRAMMABLE CYCLE OF PWM:** From 0.5 up 100 seconds.

**START-UP OPERATION:** After 3 seconds connected to the power supply.

**CERTIFICATIONS:** CE, UKCA and UL.

## WARRANTY

Warranty conditions are available on our website  
[www.novusautomation.com/warranty](http://www.novusautomation.com/warranty).